

# Variability of the Acoustic Emission Signals Generated by Partial Discharges in Mineral Oil

Michał KUNICKI

*Institute of Electrical Power Engineering and Renewable Energy  
Opole University of Technology  
Prószkowska 76, 45-758 Opole, Poland; e-mail: m.kunicki@po.opole.pl*

*(received September 11, 2018; accepted January 7, 2019)*

The main purpose of the presented research is to investigate the partial discharge (PD) phenomenon variability under long-term AC voltage with particular consideration of the selected physical quantities changes while measured and registered by the acoustic emission method (AE). During the research a PD model source generating surface discharges is immersed in the brand new insulation mineral oil. Acoustic signals generated by the continuously occurred PDs within 168 hours are registered. Several qualitative and quantitative indicators are assigned to describe the PD variability in time. Furthermore, some long-term characteristics of the applied PD model source in mineral oil, are also presented according to acoustic signals emitted by the PD. Finally, various statistical tools are applied for the results analysis and presentation. Despite there are numerous contemporary research papers dealing with long-term PD analysis, such complementary and multiparametric approach has not been presented so far, regarding the presented research. According to the presented research from among all assigned indicators there are discriminated descriptors that could depend on PD long-term duration. On the grounds of the regression models analysis there are discovered trends that potentially allow to apply the results for modeling of the PD variability in time using the acoustic emission method. Subsequently such an approach may potentially support the development and extend the abilities of the diagnostic tools and maintenance policy in electrical power industry.

**Keywords:** acoustic emission; partial discharge; insulation system; measurements; signal processing.

## 1. Introduction

In the present almost all branches of the industry are generally concerned about the non-destructive testing methods (BOCZAR *et al.*, 2016). Any production process or machine fleet maintenance is tightly depended on the quality control policy, as well as the reliability of the apparatus. For the last few decades the AE method has been recognized as one of the most popular and effective technical diagnostic methods. The AE phenomenon is widespread and relatively well described in a contemporary scientific literature (BOCZAR *et al.*, 2016; CICHÓŃ *et al.*, 2014; KUNICKI *et al.*, 2018a; OLSZEWSKA, WITOS, 2016; WITOS *et al.*, 2011). Generally the AE phenomenon is based on an ultrasound wave radiation emitted by the source into a springy resilient environment. Various different AE sources are commonly recognized and some of them are e.g. crystal structure defects motions in solids, cracks and micro cracks forming and shifting, local environ-

ment motions combined with internal friction, chemical reactions, some biological process and partial discharges. PDs are defined as micro discharges within the dielectrics that occur in the presence of the high tangential electric field stress. PDs usually appear due to the aging process of the insulation system as a result of cracks, voids, contaminations and other imperfections, within insulation materials. As one can expect of the PD they are very destructive and undesirable phenomena, in long perspective it leads to progressive local deterioration of an insulation system and may results in a complete breakdown of the insulation. Regarding the electrical power system every HV electrical device overcharge is accompanied by PD (KUNICKI *et al.*, 2018b). A significant share of all serious failures around the electrical power distribution system are partially or completely intertwined by PDs. The PD occurrence in the liquid insulation system is accompanied by numerous physical phenomena that are fundamentals of the contemporary PD testing systems, i.e.: current pulses

(KUNICKI, 2017; PATTANADECH, MUHR, 2016), electromagnetic wave emission in the UHF range (SIEGEL *et al.*, 2017; TENBOHLEN *et al.*, 2016), light emission (KOZIOŁ, 2017; KOZIOŁ *et al.*, 2016), heat emission (UTAMI *et al.*, 2009), chemical reactions and acoustic emission (BAKAR *et al.*, 2014). Application areas of the AE method for PD analysis are detection and localization of the source (HEKMATI, 2015; HOMAEI *et al.*, 2014; KUNICKI *et al.*, 2016; MEHDIZADEH *et al.*, 2013). Also there are some research works where identification of the PD source is proceeded on the grounds of the AE method (KUNDU *et al.*, 2009; 2012). The main advantages of the AE method against the other PD measuring methods are noninvasiveness and relative simplicity as well as relative safety of the measurement (BOCZAR *et al.*, 2017; KUNICKI, NAGI, 2017). Furthermore, it is still the only one method that allows the source PD localization in the on-site applications – despite the fact that there are some proposals of the UHF method application for the PD localization it is still at the laboratory research stage, and so far not applicable on-site (COENEN, TENBOHLEN, 2012; MIRZAEI *et al.*, 2013; 2015). The AE method is also characterized by some weaknesses, mainly the relatively low sensitivity which significantly limits the ability of the qualitative assessment of the PD (DE FARIA *et al.*, 2015; KUNICKI, CICHÓN, 2018b). There are some proposals of the simultaneous application of the AE method with an electrical method or the UHF method – such an approach yields some new perspectives where sensitive and noise prone methods (electrical or UHF) are supported by more immune method (AE) (ÁLVAREZ *et al.*, 2015; COENEN, TENBOHLEN, 2012; KUNICKI, CICHÓN, 2018a). Despite that there are various contemporary research papers dealing with the AE method applied for PD analysis, there is a lack of study about the variability of the acoustic signals generated by PDs within the long-term. One may point some similar approaches where the PD variability in time is investigated but usually the electrical method is applied as well as a paper solid barrier (instead of PTFE) is commonly used (KIIZA *et al.*, 2014; PENG *et al.*, 2017).

In the presented study the authors have proposed a complete advanced research on the variability of the acoustic signals generated by surface PD in mineral oil. Acoustic signals generated by PDs have not been analyzed in the time or time-frequency domain (as usually), but in the phase domain, using the partial discharges patterns (PRPD), which are usually applied regarding the electrical or UHF methods (KUNICKI *et al.*, 2018b). Furthermore, there have been presented several statistics based indicators that have not been presented so far as one research according to the AE method. Finally, the main purposes of the presented research is to achieve the long time characteristics of the selected descriptors for the AE signals generated

by the PD, and to indicate which of descriptors depend on (and how) the PD duration. The results of the presented research may extend the contemporary fundamental knowledge about the PD, and on the other hand, some of the discovered trends may be potentially useful for further research that should be focused on the PD behavior modelling and on the prediction of the PD development in the real life oil insulation systems. The results may also support research works on the charge calibration of the AE method. The presented paper is one part of the wider research project that investigates a PD variability in time using various measuring methods. Results achieved by other methods are presented in (KUNICKI, 2018; KUNICKI *et al.*, 2018a). It needs to be emphasized that in the state-of-art papers there have been also presented some other effective methods for analysis of the AE signals emitted by PDs (WITOS *et al.*, 2002), but the detailed review and comparison of those methods is outside the scope of this paper.

## 2. Fundamentals of the AE generated by PDs

As mentioned in section 1 a PD is a crucial issue that leads to the deterioration of the insulation and may evolve to some serious failure of any high voltage apparatus that it occurs in. A PD generation is an initial state of the breakdown process of the dielectrics. The breakdown process of liquid dielectrics is still not known enough and less understood contrary to the gasses and solids (CALCARA *et al.*, 2017; CAVALLINI *et al.*, 2010; FLORKOWSKI *et al.*, 2013; ZAINUDDIN *et al.*, 2011). Generally, there are two main ideas that are fundamentals for the breakdown theories of liquids. First one assumes that the breakdown process of liquids is similar to the gasses, and it is some kind of an extension of that model. However, such an approach explains breakdown of pure, ideal liquids only, it is not applicable for real dielectrics. The other theory is based on the fact that liquid dielectrics are contaminated by foreign particles such as solids, gasses or/and other liquids which has crucial influence on the dielectric strength of the liquid dielectric. Nevertheless no matter what mechanism a PD is generated by, it is always accompanied by numerous physical phenomena which are related to different forms of energy such as, e.g., chemical reactions (hydrogen and other hydrocarbon gases generation), local heat emission, acoustic wave emission, electromagnetic wave emission, light emission and local pressure adjustments. Analyzing the PD phenomenon from the acoustic point of view it may be compared to a micro explosion within a dielectric. When PD occurs in liquid dielectrics, a mechanical energy related to the PD is represented by acoustic wave – a kinetic energy is associated with particles oscillatory motion, while pressure adjustments are connected with potential energy. As a result some part of

the energy is emitted into the springy resilient environment in the form of the acoustic wave. When the wave reaches a boundary of different environments it is partially reflected, absorbed and attenuated. Generally the PD phenomenon leads on an ultrasound (20 kHz – 1.5 MHz) wave radiation. It need to be emphasized that an AE generated by a single PD event may be represented by a discrete signal. However in real insulation systems there usually multi PD sources appear at the same time, so it results in the summed sequence of single pulses. Finally, the AE signal that is received by a measuring sensor is a continuous emission of various overlapping signals (KUNICKI *et al.*, 2016).

### 3. Measurement setup

The research has been proceeded on the surface type PD model source. PDs have been generated by the model source immersed in the brand new insulation mineral oil. The HV electrode of the PD model source has been 1 cm thick brass plate with a diameter of 3 cm, while the GND electrode has been 1 cm thick steel plate with a diameter of 12 cm. All edges of both electrodes have been 1 mm rounded. Also a square solid dielectric barrier made of 8 mm PTFE and the size of 15 × 15 cm has been placed between the both electrodes. The presented research have been performed using the AE method with commonly applied instruments in the field of the PD measurements. Acoustic signals have been received by the low frequency (resonant) piezoelectric joint transducer D9241A installed on the outer oil filled tank wall. Signals from the sensor have been amplified by the preamplifier 2/4/6/ and amplifier AE2A – all mentioned instruments made by Physical Acoustic Corporation. The frequency range of the D9241A sensor was 20–100 kHz ( $\pm 6$  dB) and its sensitivity was 82 dB. The PC equipped with the external measuring interface PicoScope 5443B has been used for the signals registration – sampling frequency was 6 MHz.

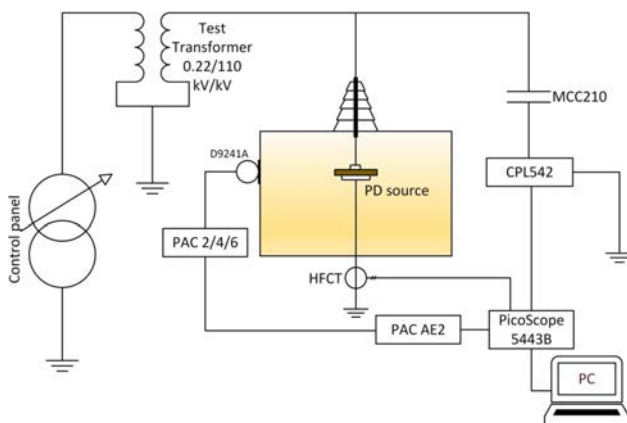

Fig. 1. Layout of the measuring set-up.

Also a dedicated magnetic grip has been supported in order to provide a constant clamp force and repeatable sensor and tank coupling. A total voltage gain of the measuring track has been 95 dB, and it has not been adjusted during all measurements as well as the PD source and the sensor locations have not been rearranged during research. Additional two measuring tracks have also been applied: one for supply voltage phase measurements and the other one for the registration of the electrical pulses generated by PDs and received by the high frequency current transformer (HFCT).

### 4. Research methodology

The presented research have been proceeded under laboratory conditions. The PD source has been powered continuously by the AC voltage with its relative level of 1.3 of the inception voltage ( $U_i$ ) of the PD source within 168 hours. The  $U_i$  voltage has been defined as the voltage at which the apparent charge of PD has been higher than 100 pC – 1 kV/s automatic controlled voltage ramp has been applied. The  $U_i$  of the applied PD source was 23 kV and the test voltage was set to 30 kV. Such a voltage level has allowed the PD to be stable and generated continuously within 168 h, with no extinctions or breakdown meanwhile – which was one of the fundamental assumptions of the research. AE signals generated by the continuously occurred PDs within 168 hours have been registered every 12 h. During every single measurement signals generated by PDs have been captured within 30000 cycles of 50 Hz supply voltage – a measurement window has been set to 20 ms, which corresponds to one 50 Hz supply voltage period, thus it supported an AE activity registration within a whole supply voltage period. The next step of the research was the thorough off-line analysis of the achieved measurement results. An assignment of various descriptors of signals generated by PD as well as indication of PD long-term duration dependency on those descriptors have been the main purpose of the further analysis. Descriptor analysis has been generally based on the PRPD patterns. In order to provide the proper data layout three key algorithms announced in (KUNICKI, CICHON, 2018b) have been applied: AE peak amplitude extraction algorithm (PAE), supply voltage phase correlation with AE signals algorithm (PCA) and AE signal delay compensation algorithm (DCA). Regarding the fact that noise free laboratory conditions have been provided no additional de-noising tools have been used. Finally, constant environmental conditions have been provided during the experiment: air temperature, humidity and pressure. Also the pressure inside of the measuring tank has been monitored during the research and its constant relative level has been provided by the relevant valves on the upper cover of the

tank. Additionally there are assigned some simple regression models that are presented in the plots. These models are presented only to support the interpretation of the results: to estimate if there are any trends discovered within the achieved characteristics (increasing, decreasing, constant, random). They are not optimized for the best fitting to the characteristics (e.g.  $R^2 > 0.95$ ), because such fitted models would not give any valuable information according to the presented research. Only 4 simple functions were used for fitting the curves: linear, 2nd order polynomial, 2nd order exponential, 2nd order Gaussian. Thus the coefficients of determination of those models are not crucial for the relevant results interpretation.

## 5. Results and discussion

As the main analysis of the results was to be proceeded on the PRPD patterns in the phase domain, so

the initial step was to prepare data into the relevant layout. The raw primal AE signals generated by PDs have been registered as a time run within 20 ms. Then dedicated algorithms mentioned in section 4 have been applied in order to achieve PRPD patterns. In Fig. 2 there have been presented some exemplary plots showing the relevant steps of the analysis. Figure 2a shows time run of the AE signal generated by PDs within 20 ms, with peak as well as RMS envelopes assigned using the Hilbert transform and discrete Fourier transform (DFT). Figure 2b shows 3D spectrogram of the signal presented in Fig. 2a, achieved using the short time Fourier transform (STFT). Finally, Fig. 2c shows the complete PRPD pattern of AE signals generated by PDs within 30000 cycles of 50 Hz supply voltage – such data have been the fundamental for the further descriptor analysis.

In Fig. 3 there have been presented PRPD patterns of the selected quantitative parameters of the AE signals in each phase angle (with  $1^\circ$  resolution)

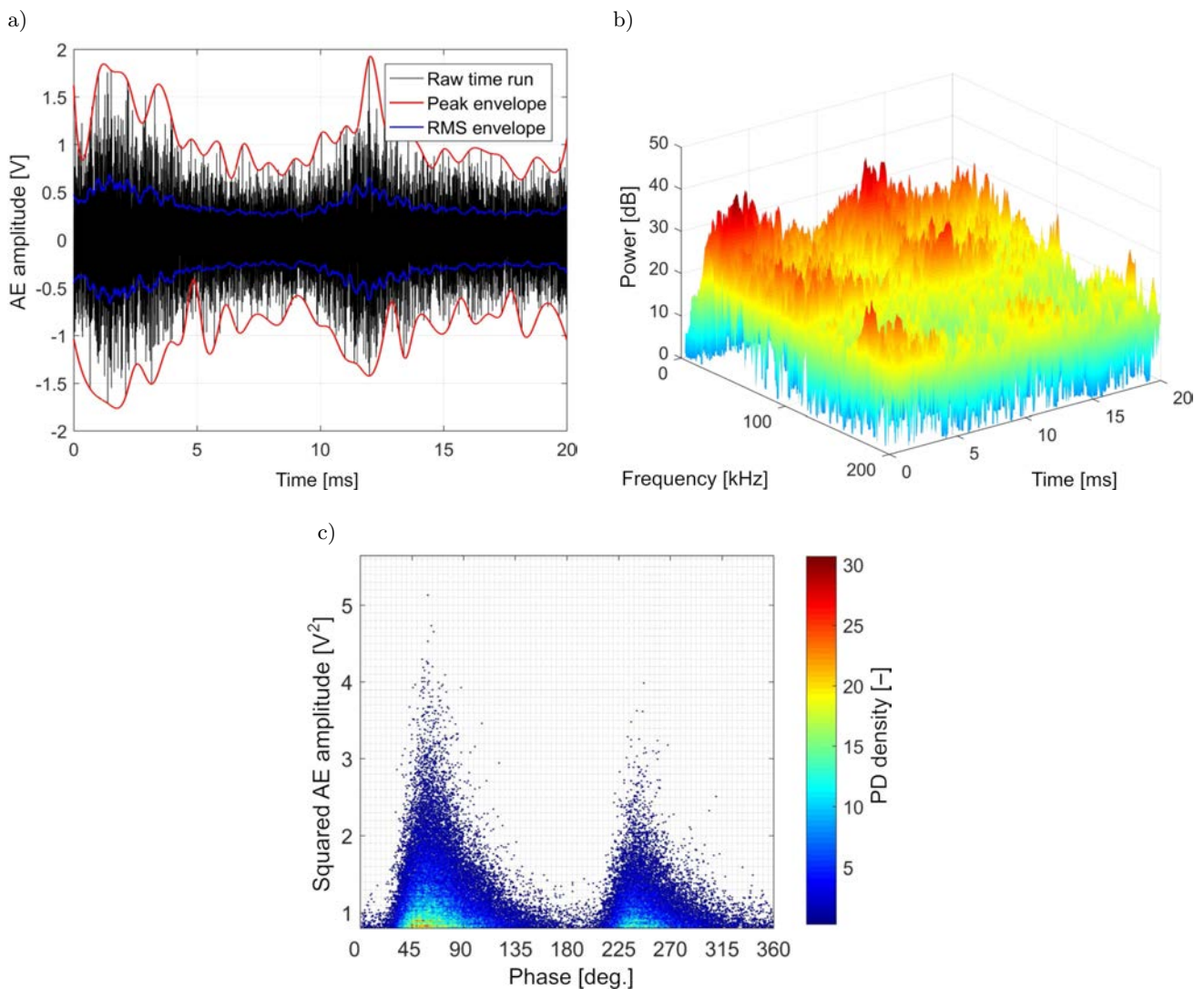

Fig. 2. Exemplary results on the different stages of the data preparation: a) time run of the AE signal generated by PDs, b) 3D spectrogram of the signal presented in a, c) PRPD pattern of AE signals generated by PDs within 30 000 cycles.



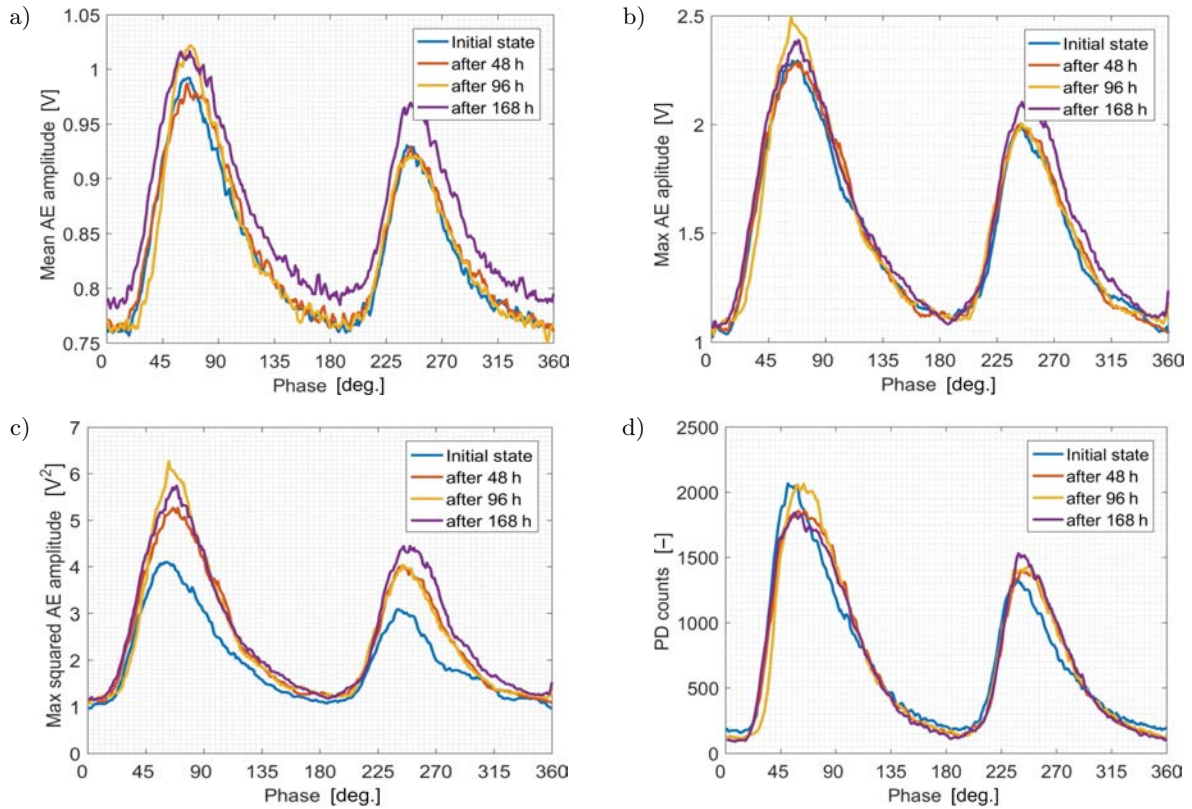

Fig. 3. PRPD of the selected quantitative parameters of AE signals obtained at relevant time steps: a) mean AE amplitude, b) max AE amplitude, c) quasi-energy of the AE signal, d) PD counts.

obtained at initial state and after 48, 96 and 168 h of continuous PD generation, respectively. A relatively high convergence of the result may be observed regarding the behaviors in both half-cycles. Also no significant phase domain adjustments, especially according to the phase angle of the max values there have been observed – max values in both halfcycles are associated with approx.  $60^\circ$  and  $240^\circ$ . Max values of all analysed parameters (except for the mean AE amplitude) are approximately 20% higher in the first half-cycle than in the second one. Regarding the mean AE amplitudes (Fig. 3a) a noticeable rise may be observed after 96 h. Similar situation is presented according to the max AE amplitudes (Fig. 3b). The highest adjustments are observed regarding the quasi-energy of the AE signal (Fig. 3c), where general rising trend has been confirmed. Furthermore some rather random than explicit behaviour has been observed regarding the PD counts analysis (Fig. 3d).

The next part of the research presented below has been dedicated to the analysis of the indicators describing the PD signals in a phase domain. In Fig. 4 there have been presented analysis results of the kurtosis of the selected AE signal parameters. The first glance it is noticeable that behaviors of all descriptors are different regarding the 1st and 2nd half-cycle. Only adjustments of the kurtosis of the max AE amplitudes

are relatively similar in both half-cycles, however their values are different.

It has also been noticed that distributions of all analyzed parameters lead to the normal distribution only in the 1st half-cycle – as the kurtosis values decrease with time and lead to the 0. According to the behaviors in the 2nd half-cycles some stabilizing trend may be observed where the kurtosis values are above 2 in case of all investigated parameters – it shows that those quantities are not normal distributed when analyzing in the long-term perspective.

The next analysed group of descriptors was skewness. Skewness analysis results of the selected AE signal parameters over the long-term are illustrated in Fig. 5. The first conclusion is the same as regarding the kurtosis: behaviors of all descriptors are different regarding the 1st and 2nd half-cycle. In case of the 1st half-cycles all values lead to zero down with the PD activity time. Significantly different situation may be noticed regarding the 2nd half-cycle scenario – skewness of mean AE amplitude as well as PD density are almost constant with its values of about 0.75. In case of the max AE amplitude and quasi-energy no explicit trends may be observed and skewness values are generally between 0.6 and 1.3.

The last stage of the research was the analysis of the descriptors related with each other: standard de-

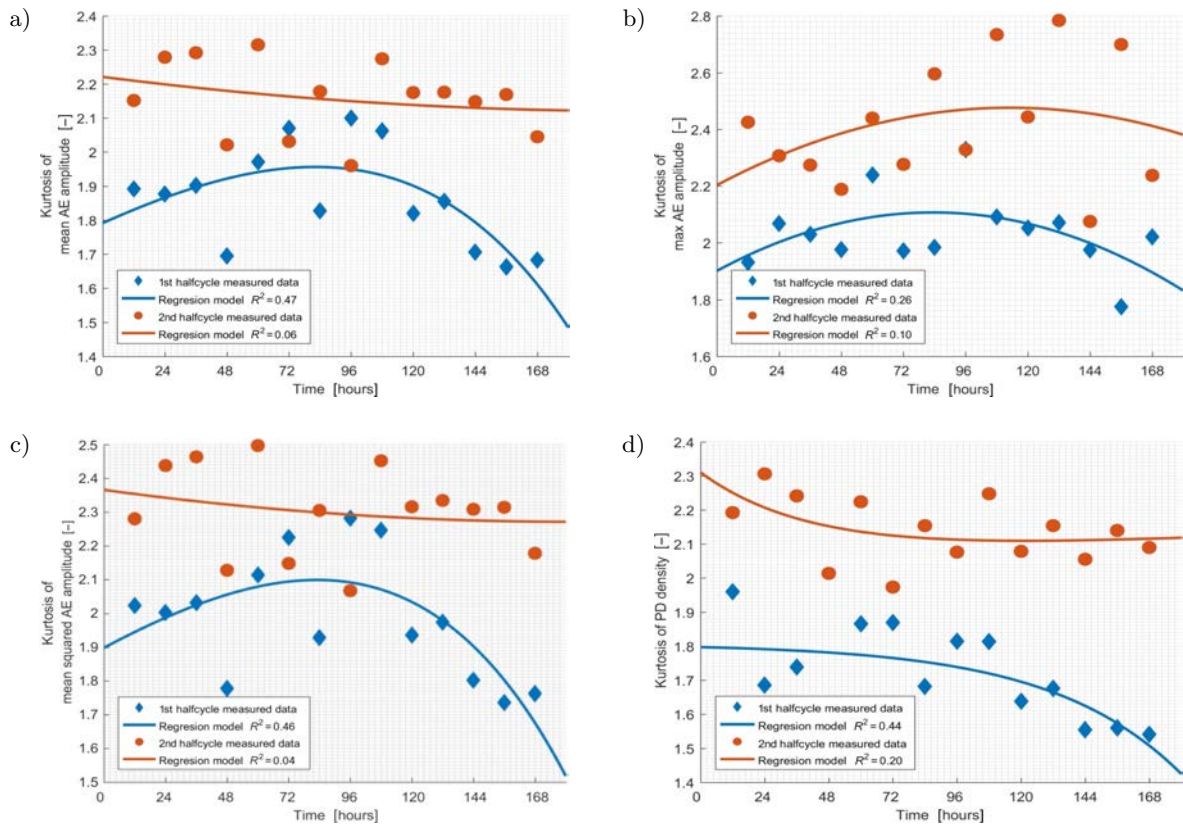

Fig. 4. Analysis of the kurtosis variability: a) of mean AE amplitude, b) max AE amplitude, c) quasi-energy of the AE signal, d) PD density.

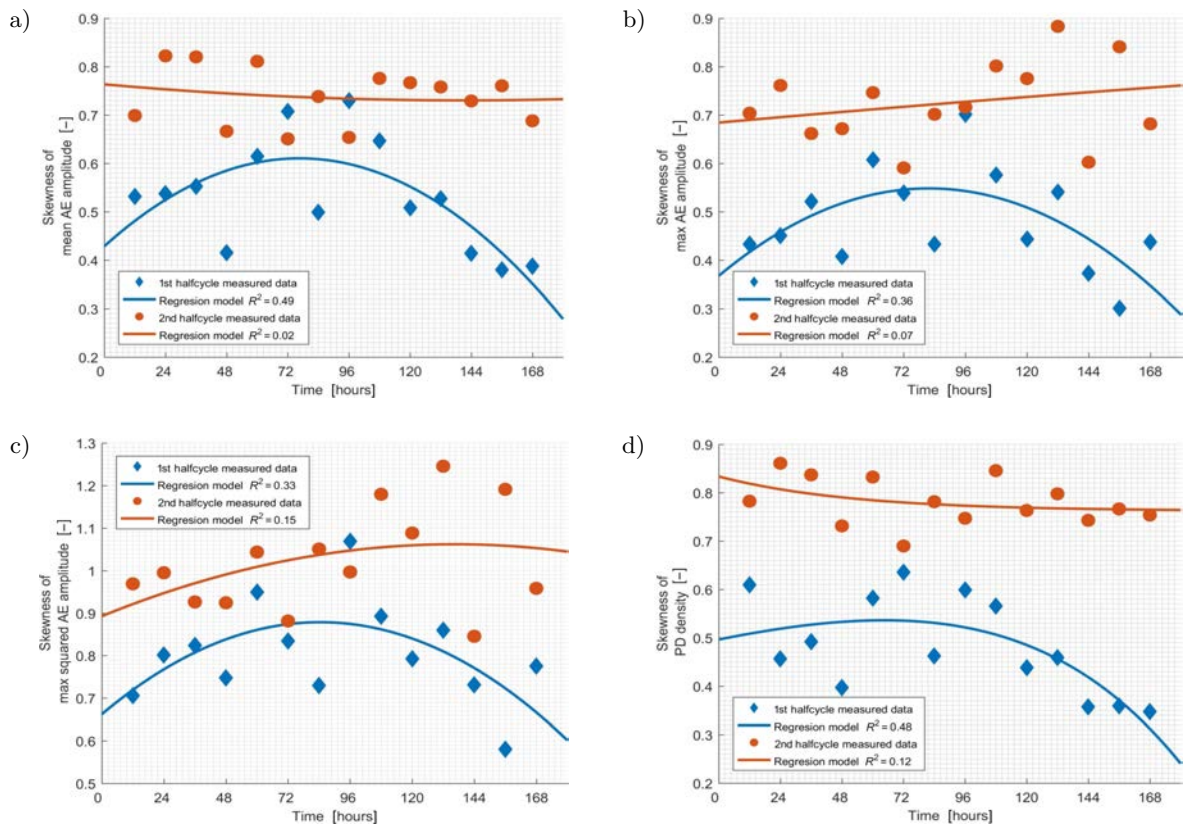

Fig. 5. Analysis of the skewness variability: a) of mean AE amplitude, b) of max AE amplitude, c) of quasi-energy of the AE signal, d) of PD density.



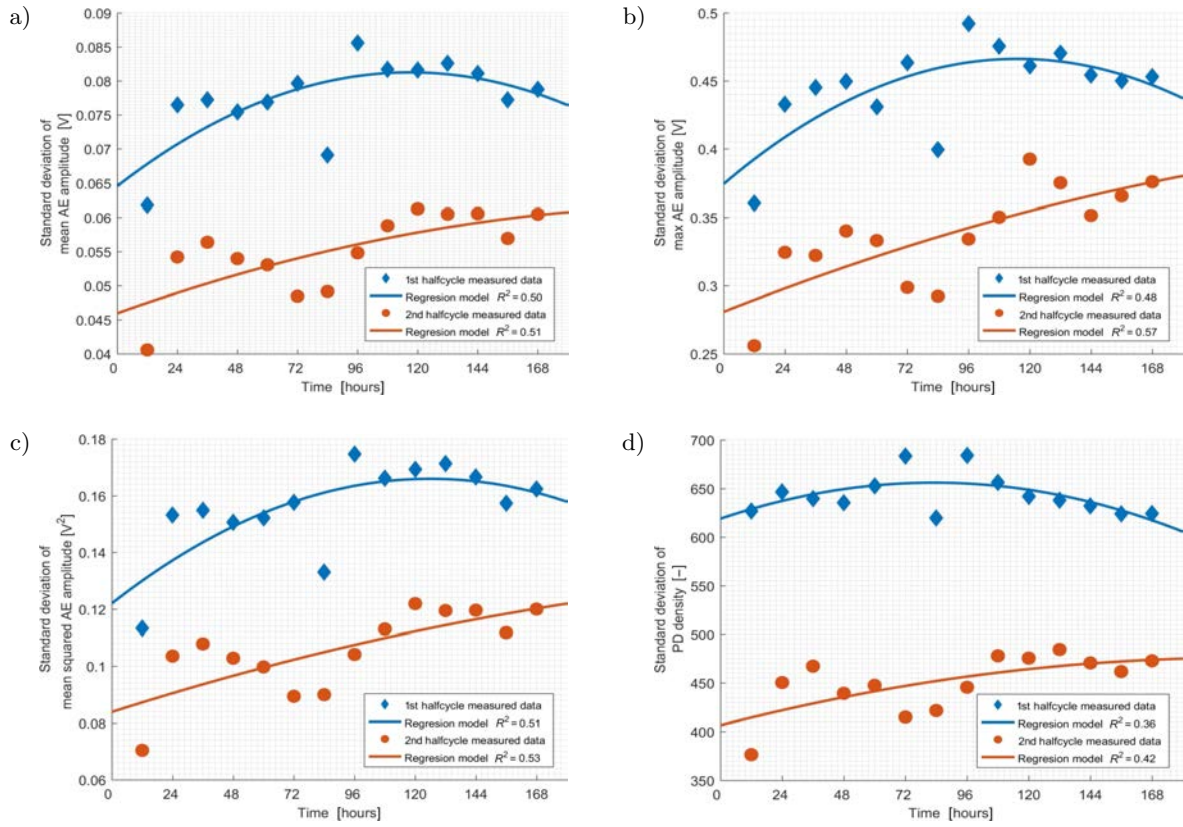

Fig. 6. Analysis of the standard deviation variability: a) of mean AE amplitude, b) of max AE amplitude, c) of quasi-energy of the AE signal, d) of PD density.

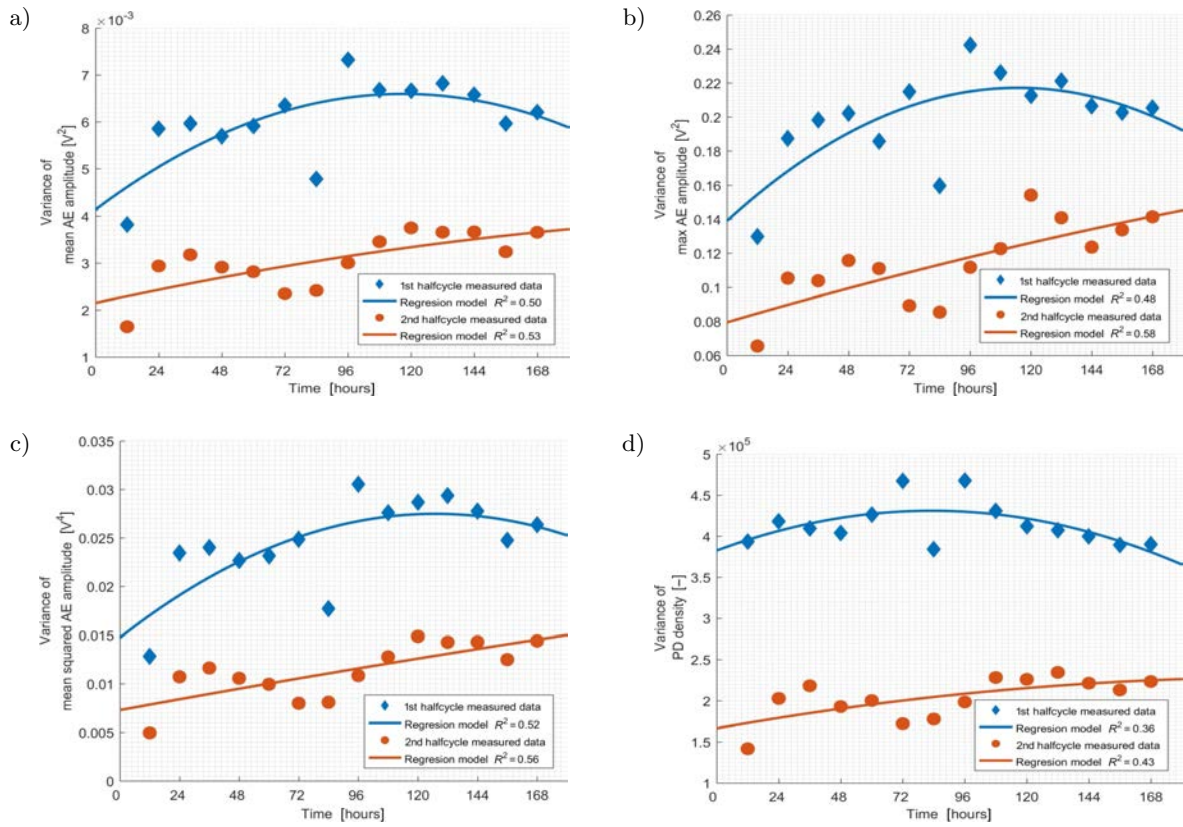

Fig. 7. Analysis of the variance variability: a) of mean AE amplitude, b) of max AE amplitude, c) of quasi-energy of the AE signal, d) of PD density.

viation and variance of the selected parameters of the AE signals generated by PDs. In Fig. 6 there have been presented results of standard deviation variability analysis. The same selected parameters of the AE signals generated by continuously occurred PDs over the long-term have been investigated. Regarding all analyzed parameters there have been observed evident trends in both scenarios: in case of the 1st half-cycle exponential raising trend has been confirmed, while according to the 2nd half-cycle a linear rising one, with some obvious sinusoidal oscillations (not included in regression models). Achieved results have showed that all investigated parameters are more spread out as the time of the PD occurring becomes longer – so there appear more signals that are relatively far-distant from mean value.

As one could expect the very similar observations have been made according to the long-term variability of the variance of the analyzed parameters. Interpretations of the characteristics presented in Fig. 7 are the same as described regarding the standard deviation analysis, so no further explanation is needed.

## 6. Conclusions

In the presented paper a methodology was proposed, and with the results from the experimental study on the variability of the AE signals generated by surface PDs in mineral oil under long-term AC voltage. Furthermore, various of the indicators that potentially describe the variability of AE signals generated by the PDs have been assigned and investigated. Contrary to other contemporary state-of-art research the AE signals have not been analyzed in the time or time-frequency domain but in the phase domain using the PRPD patterns, which are usually applied regarding the electrical or UHF methods. Such an attitude gives additional application possibilities and extends the capabilities of the PD analysis using the AE method, including the correlation analysis with other PD measuring methods, supported by the common domain of the analyzed signals (phase domain). It seems to be a crucial issue according to the modeling of the AE signals generated by PDs which is one of the fundamentals of the still not achieved yet charge calibration process of the AE method. Furthermore, regarding the presented research each of the proposed statistical indicators has been analyzed in both half-cycles separately, which also has allowed to point some potential trends in signals even if they would have not been discovered when analyzing within the whole cycle. Since many models assume that signals emitted by PDs are normal distributed some of the trends discovered within the presented paper seem to be meaningful. In view of the above some of the most relevant achievements of the presented research need to be emphasized:

- confirmed that acoustic signals emitted by PD vary in time,
- showed that most of the investigated indicators measured by AE method are not normal distributed when analyzed in the long term perspective,
- there are significant differences in behaviors of the AE signals within the 1st and 2nd halfcycle of the supply voltage when analyzed in the long term perspective,
- discovered some relevant trends in the variability of the AE signals emitted by PD in time that potentially may be meaningful regarding the PD assessment,
- confirmed that all investigated parameters are more spread out as the time of the PD occurring becomes longer – so there appear more signals that are relatively far-distant from mean value,
- skewness of mean AE amplitude as well as PD density are almost constant with its values of about 0.75,
- skewness of max AE amplitude and quasi-energy shows no explicit trends – rather random distribution,
- distributions of all analyzed parameters lead to the normal distribution only in the 1st half-cycle – as the kurtosis values decrease with time and lead to the 0,
- in case of all investigated parameters within the 2nd half-cycles some stabilizing trend is observed where the kurtosis values are above 2.

As a result the presented paper potentially extends other contemporary state-of-art research published worldwide and gives some new perspectives for the AE method application for PD measurements, especially regarding the diagnostics of the real life electrical power apparatus. Some of the pointed properties of the analyzed signals, especially the noticed trends, may be potentially useful for further research that should be focused on the PD behavior modelling, charge calibration of the AE method and on the prediction of the PD development in the real life oil insulation systems. Furthermore the presented research also extends the contemporary fundamental knowledge about the AE accompanied by the PD phenomenon. Nevertheless it needs to be emphasized that described results cannot be generalized to other particular cases – most of the results are not explicit (especially those presented in Figs 4–7) and they should be verified by further research. So in order to confirm the reliability of the noticed trends more study is required, which should include a comparison study on the results achieved using other (than PRPD) signal analysis methods and other PD setup scenarios.



### Acknowledgment

The work was co-financed from funds of the National Science Centre in Poland (NCN) as part of the Preludium research project No. 2015/19/N/ST8/03909.

### References

1. ÁLVAREZ F., GARNACHO F., ORTEGO J., SÁNCHEZ-URÁN M.Á. (2015), *Application of HFCT and UHF sensors in on-line partial discharge measurements for insulation diagnosis of high voltage equipment*, *Sensors*, **15**, 7360–7387.
2. BAKAR N., ABU-SIADA A., ISLAM S. (2014), *A review of dissolved gas analysis measurement and interpretation techniques*, *IEEE Electrical Insulation Magazine*, **30**, 3, 39–49.
3. BOCZAR T., CICHON A., WOTZKA D., FRĄCZ P., KOZIOŁ M., KUNICKI M. (2016), *Application of non-destructive testing for measurement of partial discharges in oil insulation systems*, [in:] *Non-destructive testing*, Márquez F.P.G. [Ed.], pp. 131–172, InTech.
4. BOCZAR T., CICHON A., WOTZKA D., KUNICKI M., KOZIOŁ M. (2017), *Indicator analysis of partial discharges measured using various methods in paper-oil insulation*, *IEEE Transactions on Dielectrics and Electrical Insulation*, **24**, 1, 120–128.
5. CALCARA L., POMPILI M., MUZI F. (2017), *Standard evolution of Partial Discharge detection in dielectric liquids*, *IEEE Transactions on Dielectrics and Electrical Insulation*, **24**, 1, 2–6.
6. CAVALLINI A., MONTANARI G.C., TOZZI M. (2010), *PD apparent charge estimation and calibration: A critical review*, *IEEE Transactions on Dielectrics and Electrical Insulation*, **17**, 1, 198–205.
7. CICHÓN A., BORUCKI S., WOTZKA D. (2014), *Modeling of acoustic emission signals generated in on load tap changer*, *Acta Physica Polonica A*, **125**, 6, 1396–1399.
8. COENEN S., TENBOHLEN S. (2012), *Location of PD sources in power transformers by UHF and acoustic measurements*, *IEEE Transactions on Dielectrics and Electrical Insulation*, **19**, 6, 1934–1940.
9. DE FARIA H., GABRIEL J., COSTA S., LUIS J., OLIVAS M. (2015), *A review of monitoring methods for predictive maintenance of electric power transformers based on dissolved gas analysis*, *Renewable and Sustainable Energy Reviews*, **46**, 201–209.
10. FLORKOWSKI M., FLORKOWSKA B., FURGAŁ J., ZYDRON P. (2013), *Impact of high voltage harmonics on interpretation of partial discharge patterns*, *IEEE Transactions on Dielectrics and Electrical Insulation*, **20**, 6, 2009–2016.
11. HEKMATI A. (2015), *Proposed method of partial discharge allocation with acoustic emission sensors within power transformers*, *Applied Acoustics*, **100**, 26–33.
12. HOMAËI M., MOOSAVIAN S.M., MEMBER S., ILIAS H.A. (2014), *Partial discharge localization in power transformers using neuro-fuzzy technique*, *IEEE Transactions on Power Delivery*, **29**, 5, 2066–2076.
13. KIIZA R.C., NIASAR M.G., NIKJOO R., WANG X., EDIN H. (2014), *Change in partial discharge activity as related to degradation level in oil-impregnated paper insulation: Effect of high voltage impulses*, *IEEE Transactions on Dielectrics and Electrical Insulation*, **21**, 3, 1243–1250.
14. KOZIOŁ M. (2017), *Mathematical model of optical signals emitted by electrical discharges occurring in electroinsulating oil*, *E3S Web of Conferences*, **19**, 01042.
15. KOZIOŁ M., WOTZKA D., BOCZAR T., FRĄCZ P. (2016), *Application of optical spectrophotometry for analysis of radiation spectrum emitted by electric arc in the air*, *Journal of Spectroscopy*, **2016**, article ID: 1814754.
16. KUNDU P., KISHORE N.K., SINHA A.K. (2009), *A non-iterative partial discharge source location method for transformers employing acoustic emission techniques*, *Applied Acoustics*, **70**, 11–12, 1378–1383.
17. KUNDU P., KISHORE N.K., SINHA A.K. (2012), *Identification of two simultaneous partial discharge sources in an oil-pressboard insulation system using acoustic emission techniques*, *Applied Acoustics*, **73**, 4, 395–401.
18. KUNICKI M. (2017), *Comparison of capacitive and inductive sensors designed for partial discharges measurements in electrical power apparatus*, *E3S Web of Conferences*, **19**, article no 01035.
19. KUNICKI M. (2018), *Behavior of partial discharges in mineral oil with solid dielectric barrier under long-term AC voltage*, *Proceedings of 2nd International Conference on Dielectrics*, pp. 1–4, Budapest, Hungary.
20. KUNICKI M., CICHÓN A. (2018a), *Analysis on partial discharges variability in mineral oil under long-term AC voltage*, *IEEE Transactions on Dielectrics and Electrical Insulation*, **25**, 5, 1837–1845.
21. KUNICKI M., CICHÓN A. (2018b), *Application of a phase resolved partial discharge pattern analysis for acoustic emission method in high voltage insulation systems diagnostics*, *Archives of Acoustics*, **43**, 2, 235–243.
22. KUNICKI M., CICHÓN A., BORUCKI S. (2016), *Study on descriptors of acoustic emission signals generated by partial discharges under laboratory conditions and in on-site electrical power transformer*, *Archives of Acoustics*, **41**, 2, 265–276.
23. KUNICKI M., CICHON A., BORUCKI S. (2018a), *Measurements on partial discharge in on-site operating power transformer: A case study*, *IET Generation, Transmission and Distribution*, **12**, 10, 2487–2495.
24. KUNICKI M., CICHÓN A., NAGI Ł. (2018b), *Statistics based method for partial discharge identification in oil paper insulation systems*, *Electric Power Systems Research*, **163**, 559–571.

25. KUNICKI M., NAGI L. (2017), *Correlation analysis of partial discharge measurement results*, Proceedings of 2017 IEEE International Conference on Environment and Electrical Engineering and 2017 IEEE Industrial and Commercial Power Systems Europe (EEEIC/I&CPS Europe), pp. 1–4, Milan, Italy.
26. MEHDIZADEH S., YAZDCHI M., NIROOMAND M. (2013), *A novel AE based algorithm for PD localization in power transformers*, Journal of Electrical Engineering and Technology, **8**, 6, 1487–1496.
27. MIRZAEI H., AKBARI A., GOCKENBACH E., MIRALIKHANI K. (2015), *Advancing new techniques for UHF PD detection and localization in the power transformers in the factory tests*, IEEE Transactions on Dielectrics and Electrical Insulation, **22**, 1, 448–455.
28. MIRZAEI H.R., AKBARI A., GOCKENBACH E., ZANJANI M., MIRALIKHANI K. (2013), *A novel method for ultra-high-frequency partial discharge localization in power transformers using the particle swarm optimization algorithm*, IEEE Electrical Insulation Magazine, **29**, 2, 26–39.
29. OLSZEWSKA A., WITOS F. (2016), *Identification of acoustic emission signals originating from the core magnetization of power oil transformer*, Archives of Acoustics, **41**, 4, 799–812.
30. PATTANADECH N., MUHR M. (2016), *Partial discharge inception voltage investigation of mineral oil: Effect of electrode configurations and oil conditions*, IEEE Transactions on Dielectrics and Electrical Insulation, **23**, 5, 2917–2924.
31. PENG P., CUI Y., JI S., ZHANG F., CAO P., ZHU L. (2017), *Evolution of partial discharge of oil-paper insulation under long-term AC voltage*, 2016 IEEE International Power Modulator and High Voltage Conference, IPMHVC 2016, pp. 166–170.
32. SIEGEL M., BELTLE M., TENBOHLEN S. (2017), *Application of UHF sensors for pd measurement at power transformers*, IEEE Transactions on Dielectrics and Electrical Insulation, **24**, 1, 331–339.
33. TENBOHLEN S., COENEN S., DJAMALI M., MÜLLER A., SAMIMI M.H., SIEGEL M. (2016), *Diagnostic measurements for power transformers*, Energies, **9**, 5, 1–25.
34. UTAMI N.Y., TAMSIR Y., PHARMATRISANTI A., GUMILANG H., CAHYONO B., SIREGAR R. (2009), *Evaluation condition of transformer based on infrared thermography results*, [in:] Proceedings of the IEEE International Conference on Properties and Applications of Dielectric Materials, pp. 1055–1058.
35. WITOS F., GACEK Z., OPILSKI A. (2002), *A new acoustic emission descriptor for modelled sources of partial discharges*, Archives of Acoustics, **27**, 1, 65–77.
36. WITOS F., OLSZEWSKA A., SZERSZEŃ G. (2011), *Analysis of properties characteristic for acoustic emission signals recorded on-line in power oil transformers*, Acta Physica Polonica A, **120**, 4, 759–762.
37. ZAINUDDIN H., MITCHINSON P.M., LEWIN P.L. (2011), *Investigation on the surface discharge phenomenon at the oil-pressboard interface*, Proceedings – IEEE International Conference on Dielectric Liquids, pp. 1–4.