

Research on the Optimization of Logistics Simulation to the Container Yard Gate System of Hazardous Chemicals Port

Yezhu Cui^{*a}, Yongjin Xie^b

^a Hebei University of Environmental Engineering, Qinhuangdao 066102, China

^b Langfang Teachers University, Langfang 065000, China
 yezhu0903@126.com

This paper analyzes the handling of hazardous chemicals in port and the management of operating them, optimizes the operation of goods yard gate of port, builds the mathematical model of yard gate and gets the optimal operation scheme of gate system by simulation. Aiming at the potential hazards of chemicals in port (such as polymerization, explosion, leakage, static and mixture of oil and gas), this paper draws up corresponding precautionary measures, designs the procedures of handling and managing hazardous chemicals in port, classifies hazardous chemicals to be packaging chemicals, bulk solid chemicals, bulk liquid chemicals and bulk liquid gas, designs corresponding standards of handling and transport for each class, builds the mathematical model of yard gate system of hazardous chemicals in port, sets constraint conditions and objective function, uses simulation software to simulate the model and makes comparison with actual statistical data. The result of comparison indicates small error between simulated data and actual statistical result. The largest error is only 7.7%. Feasibility and validity of the model built in this paper are verified. According to annual work amount of the yard gate of port, the amount of entrance and exit can be changed correspondingly. This can guarantee the optimal efficiency of logistics system.

1. Introduction

With the development of high-grade, high-precision and advanced technology, more and more non-renewable energy resource and chemical products are needed in the whole world. As the main mode of transportation of hazardous chemicals, marine transport has potential safety hazard in the process of transport, handling, storage and secondary transport. The hazardous chemicals in port include packaged or loose-packed liquid, gas and solid chemicals. The main potential hazards of chemicals in the process of handling and transport are fire disaster, explosion, thermal expansion, gasification, self-reaction (such as spontaneous combustion and polymerization), corrosion and toxicity (Zhao, 2007; Liu et al., 2012; Batarliene, 2008). The production and logistical transport of hazardous chemicals must be strictly managed (Carson and Mumford, 2003; Ellis, 2010; Bode et al., 2002; Lee et al., 2003).

Because of the particularity of hazardous chemicals, they shall be transferred as soon as possible in the process of handling and transport. Therefore, it is very important to keep expedite transport in port and raise the transport efficiency of trucks. The goods yard gate of port is the most important link in supply chain system of port. The design of gate and passageway directly relates to the transport efficiency of trucks (Lang, 2004; Park and Dragović, 2009; Bielliabb, 2006; Nam, Kwak and Yu, 2002; Imai, Nishimura and Papadimitriou, 2001).

This paper analyzes the handling of hazardous chemicals in port and the management of operating them, optimizes the operation of goods yard gate in port, builds the mathematical model of yard gate and gets the optimal scheme of operating gate system by simulation.

2. The structure of managing handling and operation of hazardous chemicals in port

Hazardous chemicals are different from common goods. Because of their inflammability, explosiveness and diffusivity, corresponding special scheme must be made for the process of handling and storage.

As for hazardous chemicals, the following precaution measures must be taken:

(1) Prevent the polymerization and explosion of gas. Some dangerous chemical gas with low ignition point is stored in storage tanks in port. They are explosive. If they are not properly stored, air may enter the storage tanks and mixed explosive gas will form. Potential hazards exist in the process of handling and transporting storage tanks.

(2) Prevent the leakage of hazardous chemicals. Liquid chemicals can be leaked easily if they are not stored properly, which may cause atmospheric pollution and explosion. While handling and transporting liquid chemicals, transport pumps, valves and storage tanks shall be often inspected. Once problems are found, they shall be timely solved.

(3) Prevent the hazard of static. Static shall be avoided in the storage tanks or warehouse of chemicals. Workers shall walk in warehouse as little as possible and must wear anti-static clothes and shoes. At the entrance of warehouse, static-elimination equipment must be installed and used.

(4) Prevent the mixture of oil and gas. Yard of port shall timely update storage equipment, use advanced technology of sealed handling and storage and prevent the mixture of oil chemicals and gas chemicals.

The structure of managing the handling and operation of hazardous chemicals in port designed in this paper is shown in figure 1. Hazardous chemicals are classified to be packaging chemicals, bulk solid chemicals, bulk liquid chemicals and bulk liquid gas. Corresponding standards of handling and transport are designed according to the characters of each class of chemicals. In the process of design, the factor of supervision shall be considered. Personnel management must be implemented meeting the standards designed in advance.

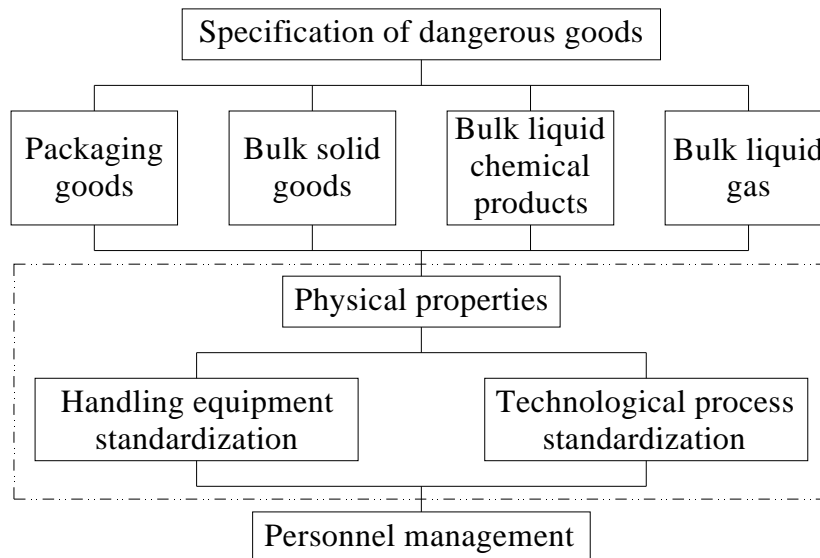

Figure 1: Structure of hazardous chemicals handling in port

3. Research on the optimization of yard gate system in port

3.1 Model building

Because of the particularity of hazardous chemicals, they shall be transferred as soon as possible in the process of handling and transport. Therefore, it is very important to keep expedite transport in port and raise the transport efficiency of trucks. The goods yard gate of port is the most important link in supply chain system of port. The design of gate and passageway directly relates to the transport efficiency of trucks. Schematic diagram of layout and work flow of container yard gate system is shown in Figure 2.

To optimize the container yard gate system in port, objective function of optimization is the largest number of trucks passing the gate during one day. Decision vector X is:

$$X = (x_1, x_2, x_3, x_4, x_5) \quad (1)$$

x_1 - x_5 are the quantity of entrance passageways, the quantity of exist passageways, the expected service time of loaded trucks and unloaded trucks at entrance, the expected service time of loaded trucks and unloaded trucks at exit, respectively. Objective function of optimization $f(x)$ is:

$$\min f(x) = C_1x_1 + C_2x_2 + C_3x_3 + C_4x_4 + C_5x_5 \tag{2}$$

In the process of optimization, the following constraints shall be considered: the work amount of gate system is same as the handling capacity of wharf; the length of queue at gate is shorter than the permitted largest length of queue; use ratio of passageway is in stipulated range.

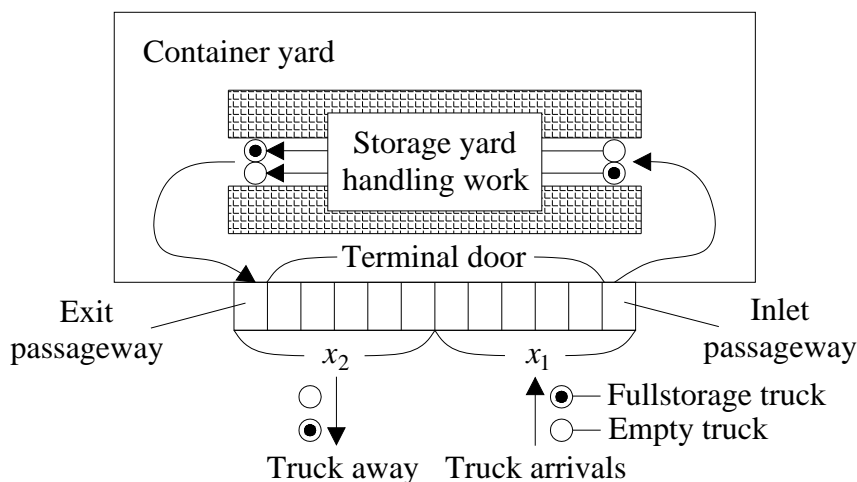

Figure 2: Schematic diagram of layout and work flow of container yard door system

Queuing theory can be used in the optimization system of warehouse gate. The optimization simulation model is shown in Figure 3.

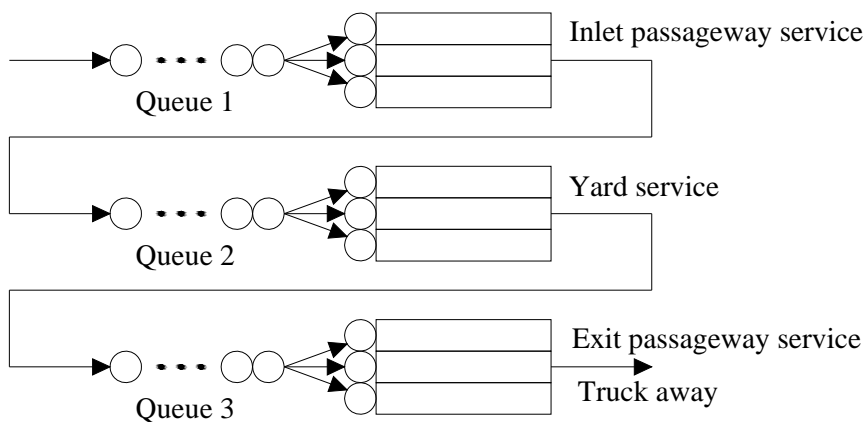

Figure 3: Simulation model of container yard gate system based on queuing theory

Some assumptions are made to optimization model based on queuing theory; loaded trucks and unloaded trucks are regarded as customers. They are randomly distributed according to the sequential order when they arrive at the gate. If the service station of the gate is serving other customer, the customer needs to wait. Service station of gate, yard of hazardous chemicals and exit passageway are service system at three levels, respectively. Each system can only serve one customer at the same time.

3.2 Instance analysis

To verify the validity of the method in this paper, gate service system of hazardous chemicals yard of a large port is researched. Relevant data derives from statistics of the port. Annual hazardous chemicals work amount of the gate system is shown in Figure 4.

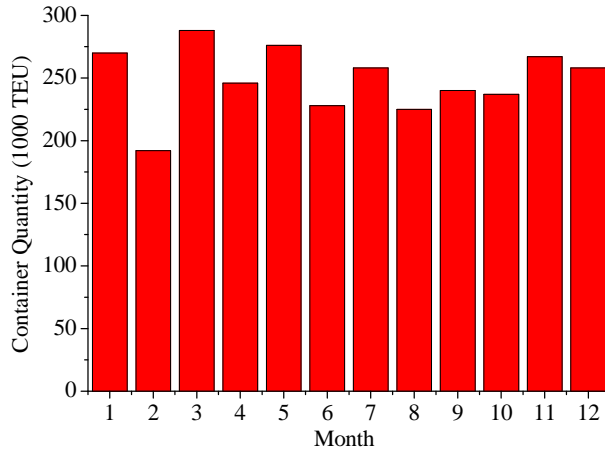

Figure 4: Distributing graph of gate work amount in one year

The statistics of unloaded trucks and loaded trucks passing the gate system in one day is shown in Figure 5.

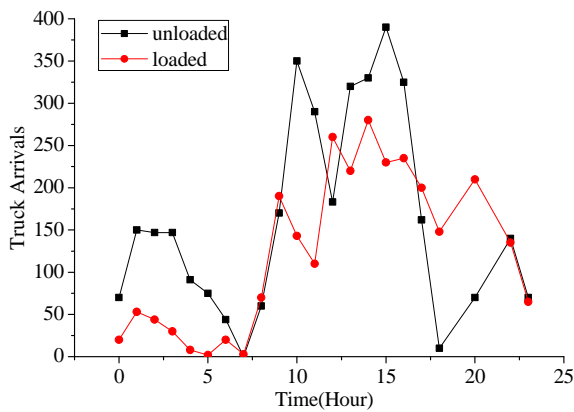

Figure 5: Distributing graph of arrival number counted by hour in one day

Arena software is used to simulate that to get the data of trucks arriving at the gate system in one day. The comparison with practical statistical data is shown in Figure 6. In the figure, we can see that simulation result is almost same as practical statistical result, which verifies the validity and feasibility of the model built in this paper.

Table 1 analyzes the relative errors between simulation result and practical statistic result in the indexes of gate system use ratio, waiting time of trucks and service time of gate system. In the table, we can see small relative errors between simulation result and practical statistic result. The largest error is only 7.7%. The error of other indexes are smaller than 5.5%. This also verifies validity of the algorithm in this paper.

Table 1: Model validation results comparison

Parameters		Practical data	Simulated data	Error ratio
External average port time(min)		31.9	31.2	2.2%
Utilization ratio (%)	ρ_1	18.02	17.05	5.4%
	ρ_2	13.03	12.46	4.4%
External average waiting time(s)	Entrance	6.3	6.0	4.8%
	Exit	3.1	3.0	3.2%
Work truck numbers	Fullstorage truck	350.0	350.0	0.0%
	Empty truck	241.0	243.0	0.8%
Entrance lane service time(s)	Fullstorage truck	46.6±6.1	43.0±7.2	7.7%
	Empty truck	35.5±6.0	33.6±5.8	5.4%
Exit lane service time(s)		28.0±5.1	26.7±4.9	4.6%

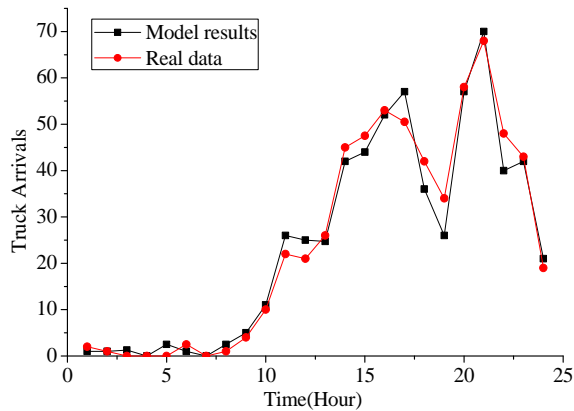

Figure 6: Comparison between simulation output result and practical data

The quantity of passageways of gate system is calculated in the following formula:

$$N = \frac{Q_n (1 - K_b) K_{bv}}{T_{yk} T_d P_d q_c} \quad (3)$$

By calculation, $N=20\sim 25$. Namely, the quantity of exits and entrances of gate system is 20~25. Figure 7 shows the optimal solution of entrance passageway and exit passageway when annual work amount of gate system. In the figure, the quantity of entrances and exits do not change when the amplitude of variation is smaller than 5%. When the amplitude of variation is 10%, one entrance increases or decreases; the quantity of exits does not change. When the amplitude of variation is within 20%, one exit increases or decreases; the quantity of entrances does not change. This can guarantee the highest efficiency of transport.

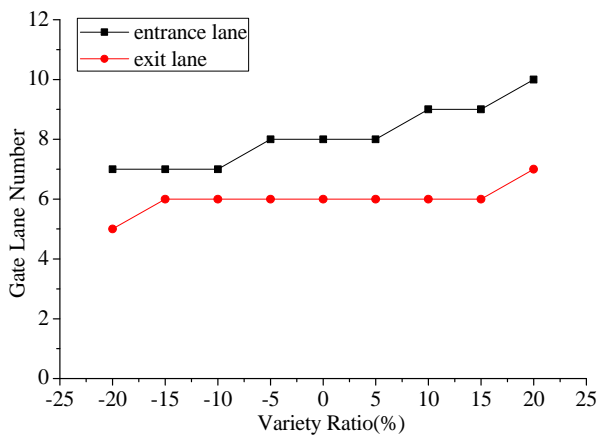

Figure 7: Change of planning passageway number when Q_n changes

4. Conclusions

This paper analyzes the handling of hazardous chemicals in port and the management of operating them, optimizes the operation of goods yard gate of port, builds the mathematical model of yard gate and gets the optimal operation scheme of gate system by simulation. The conclusions are listed below:

(1) Corresponding precautionary measures are formulated aiming at the potential hazards of the hazardous chemicals in port, such as polymerization, explosion, leakage, static and mixture of oil and gas. The structure of managing handling and operation of hazardous chemicals in port is designed. Hazardous chemicals are classified to be packaging chemicals, bulk solid chemicals, bulk liquid chemicals and bulk liquid gas. Corresponding technological standards of handling and transport are designed aiming at each class.

(2) The mathematical model of yard gate system for the hazardous chemicals in port is built. In addition, this paper sets constraint conditions and objective function and uses simulation software to simulate the model and compare the simulation result with practical statistical data. The result of comparison indicates small

relative error between simulation result and practical statistical data. The largest error is only 7.7%. This verifies the feasibility and validity of the model built in this paper. The optimal transport efficiency of logistics system can be guaranteed through correspondingly changing the quantity of entrances and exits based on the work amount of yard gate in port.

Acknowledgements

Project for soft-science of Hebei science and technology plan in 2016, Research on Optimization and Integration of Port Supply Chain Based on Cloud Computing (Item number: 16454222).

Reference

- Batarliene N., 2008, Risk analysis and assessment for transportation of dangerous freight, *Transport*, 23(2), 98-103, DOI: 10.3846/1648-4142.2008.23.98-103
- Bielliabb M., 2006, Object oriented model for container terminal distributed simulation, *European Journal of Operational Research*, 175(3), 1731-1751, DOI: 10.1016/j.ejor.2005.02.037
- Bode S., Isensee J., Krause K., Michaelowa A., 2002, Climate policy: analysis of ecological, technical and economic implications for international maritime transport. *International Journal of Maritime Economics*, 4(2), 164-184, DOI: 10.1057/palgrave.ijme.9100038
- Carson P., Mumford C., 2003, Transportation of chemicals, *Loss Prevention Bulletin*, 170(1), 11-17, DOI: 10.1021/cen-v029n021.p2028
- Ellis J., 2010, Undeclared dangerous goods - risk implications for maritime transport, *Wmu Journal of Maritime Affairs*, 9(1), 5-27, DOI: 10.1007/bf03195163
- Imai A., Nishimura E., Papadimitriou S., 2001, The dynamic berth allocation problem for a container port, *Transportation Research Part B Methodological*, 35(4), 401-417, DOI: 10.1016/s0191-2615(99)00057-0
- Lang N., 2004, Economic analysis of a container terminal simulation, *International Journal of Logistics Research & Applications*, 7(3), 263-279, DOI: 10.1080/13675560412331298509
- Lee T.W., Park N.K., Lee D.W., 2003, A simulation study for the logistics planning of a container terminal in view of scm, *Maritime Policy & Management*, 30(3), 243-254, DOI: 10.1080/0308883032000114072
- Liu L., Sun L., Li J., Li C., Hu X., 2012, An approach to the real-time risk analysis for hazardous material transportation., 15(1), 361-366, DOI: 10.1007/978-3-642-29977-3_36
- Nam K.C., Kwak K.S., Yu M.S., 2002, Simulation study of container terminal performance, *Journal of Waterway Port Coastal & Ocean Engineering*, 128(14), 126-132.
- Park N.K., Dragović B., 2009, A study of container terminal planning, *Fme Transactions*, 37, 203-209.
- Zhang H.L., Jiang Z.B., Xu H., 2006, Simulation study of container terminal scheduling system, *Journal of Shanghai Jiaotong University*, 40(6), 1024-1030.
- Zhao L.J., 2007, Risk analysis of dangerous chemicals transportation, *Systems Engineering, Theory & Practice Online*, 27(12), 117-122, DOI: 10.1016/s1874-8651(08)60077-0