

Separation Performance of Polymer Membranes for Organic Solvent Mixtures

Lukas Wessely*, Wolfgang M. Samhaber

Johannes Kepler University Linz, Welsersstraße 42 4060 Leonding
lukas.wessely@jku.at

The current investigation directs the focus at the performance of SRNF membranes for the separation of organic solvent mixtures without dissolved species. A correlation between operating parameters (temperature, pressure) and differences in separation performance (fluxes, retention) for commercially available solvent stable nanofiltration membranes of different materials is shown. The membranes are applied in laboratory tests to separate different compositions of organic solvent mixtures. The experiments are conducted over weeks to ensure the constancy of the membranes and respectively the obtained data.

1. Introduction

Based on the progress in organophilic nanofiltration (SRNF, ONF) during the last few years this technique seems to be one of the most promising to replace conventional separation or at least complement it (Bhanushali et al., 2001; Ebert et al., 2006; Silva, Han, Livingston, 2005; Stamatialis et al. 2006). In contrary to the thermal separation processes (distillation, extraction, adsorption) SRNF holds the benefit of sparing phase transition and therefore increasing energy efficiency, thus reducing CO₂ emission.

Especially mixtures which demand high energy input using conventional techniques or even resist them are predestined to be processed using solvent resistant nanofiltration. Short term investigations of different groups have shown that the separation performance of selected membranes is quite different concerning the solvent systems examined (Raman, Cheryan, Rajagopalan, 1996; Koseoglu, Lawhon, Lusas, 1990; Schmidt et al. 1998; Yang, Livingston, Freitas dos Santos, 2001)

Our prior investigations could show that the separation performance of commercially available membranes is quite different concerning the solvent system examined. Starting from these results this investigation focuses on the influence of parameters like pressure and temperature to show their effects on the separation performance.



2. Experimental

Commercially available solvent stable nanofiltration membranes of different manufacturers are used in this investigation. The experiments were conducted over weeks to ensure the constancy of the obtained data (especially the reproducibility of the retention coefficients and fluxes). All the chemicals had at least p.A. grade and were purchased by different suppliers.

2.1 Chemicals

Common organic solvents were used for the investigations on binary mixtures and their separability. The used pairs and their properties can be found in table 1. There are binary mixtures found with components of quite similar characteristics (molar mass, density,...) as well as ones with quite different features concerning physical and/or chemical properties of the ingredients.

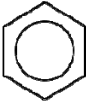
Table 1:- properties of the used chemicals (Lide, 1997)

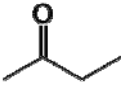
	structure	molecular mass [g/mol]	boiling point [°C]	density [g/cm ³]	viscosity [mPas]	dipole moment [D]
Benzene		78.11	80.0	0.88	0.65	0
Cyclohexane		84.16	80.7	0.78	0.98	0
Ethanol		46.07	78.2	0.79	1.07	1.69
2-Butanone		72.11	79.5	0.81	0.42	2.78

Criterion for the chosen mixtures was their ability to form azeotropes what limits the separability by conventional (thermal) separation processes. The used azeotropes and their properties can be seen in Table 2.

Table 2: Used azeotropes

	mass ratio	boiling point [°C]	density [g/cm ³]
Benzene/ Cyclohexane	0.55/0.45	77.8	0.84
Ethanol/ 2-Butanone	0.40/0.60	74.8	0.8

2.2 Membranes

Four commercially available membranes of different manufacturers, with different properties and made of different materials were used for the examinations. One main aspect was the long term solvent stability which was analysed by storing the membranes in the respective solvent for at least six weeks before starting the experiments. The experiments were then conducted over weeks to check the stability of the membranes' performance.

All of the membranes were basically of polymeric nature with anisotropic polyimide based membranes obtained from Evonik and MET and silicon based membranes obtained from GMT/Borsic and Koch. The manufacturer's information about the MWCO (molecular weight cut-off) was spared for this investigation as it is normally determined in aqueous surroundings and therefore can't be compared with or transferred to organic solvent systems (Yang, Livingston, Freitas dos Santos, 2001).

2.3 Set-up

The used set-up basically consisted of four membrane cells which are operating in a cross flow mode. Each membrane cell contained a membrane with an active area of 50 cm². The feed tank featured a volume of approximately 1.8 L and the applied transmembrane pressure was chosen to be between 10 and 30 bars depending on the different systems and their permeabilities and fluxes. The temperature was held constant at 20 °C, 25 °C and 30 °C using a double pipe heat exchanger located in the retentate pipeline.

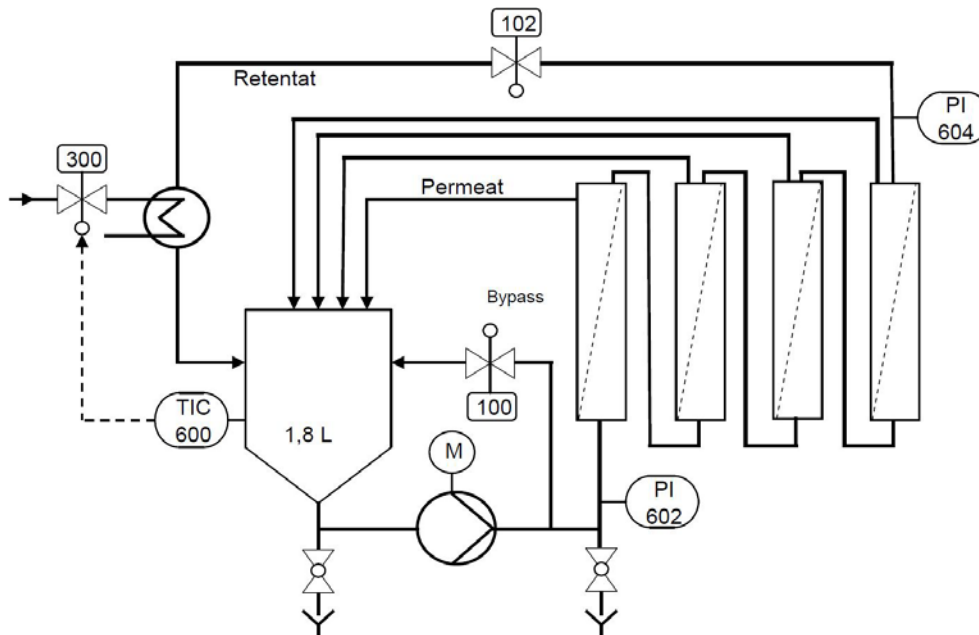

Figure 1: Flow chart of the used plant

The permeabilities and fluxes were obtained by measuring the mass of permeate which was separated within five minutes. Every reading point was done several times to gain a reliable average value.

For every combination of solvents not only the azeotropic mixture was investigated but the system over the whole range of composition. The membranes were not changed during the investigation of each solvent system.

2.4 Analytics

Due to different diffusion velocity through the polymers of the used membranes the components of the mixtures were found in different ratios in the feed/retentate and permeate. As there are several possibilities to describe these effects for this work the retention R was used. The retention R of one component through a membrane is defined by equation (1)

$$R = 1 - \frac{y_A}{x_A} \quad (1)$$

with y_A meaning the concentration of component A in the permeate and x_A meaning the concentration of component A in the retentate, both in mass fraction.

To determine the composition of feed and permeate an HP5890 series II gas chromatograph with a J&W Scientific column (DB-XLB, 30m, 0.25 μ m film) and a mass selective detector (HP 5971 MSD) was used. The method of external standards was applied to determine the exact composition of the samples.

Furthermore the normalized flux (L/m²hbar) is used to describe the amount of permeate produced by each membrane.

3. Results

3.1 Benzene/Cyclohexane

Figure 1 gives the results for correlation between Pressure/Fluxes of the best performing PDMS- and PI-based membranes, Figure 2 the results for correlation between the Temperature/Flux for the respective membranes. Figures 3 and 4 show the correlation between Pressure/Retention (Cyclohexane) and Temperature/Retention (Cyclohexane).

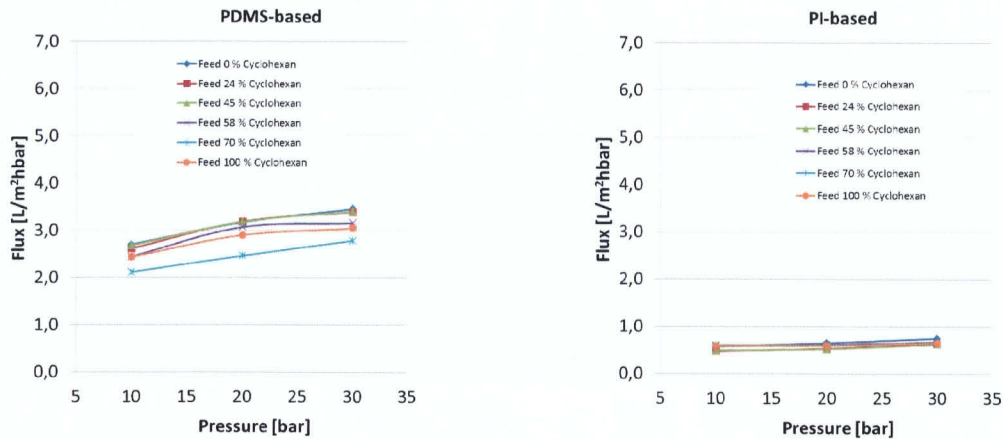

Figure 2 - correlation between Pressure and Flux

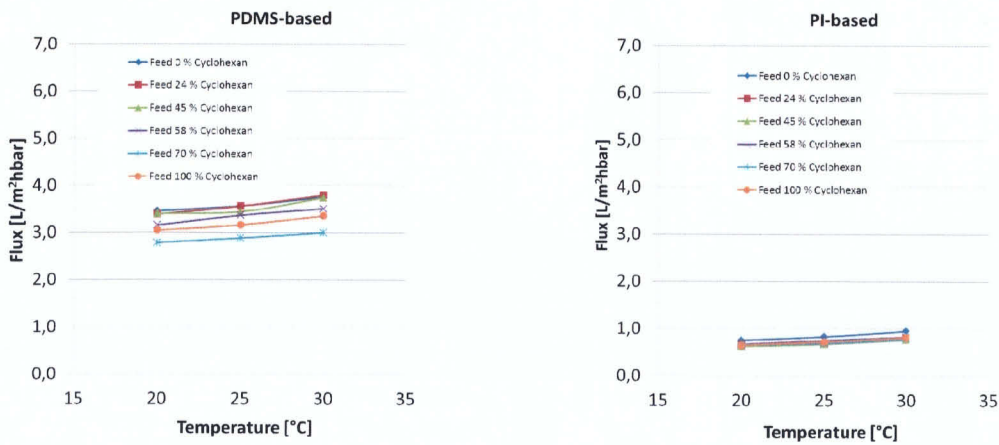

Figure 3: Correlation between Temperature and Flux

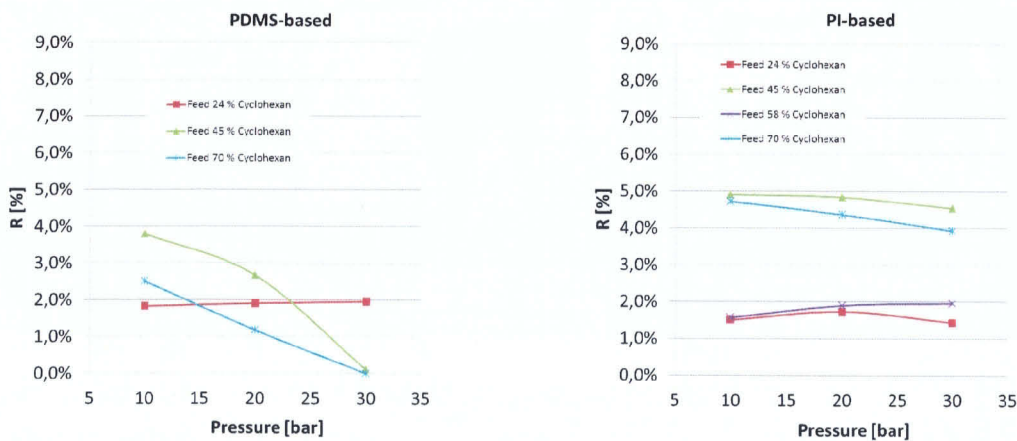

Figure 4: Correlation between Pressure and Retention (Cyclohexane)

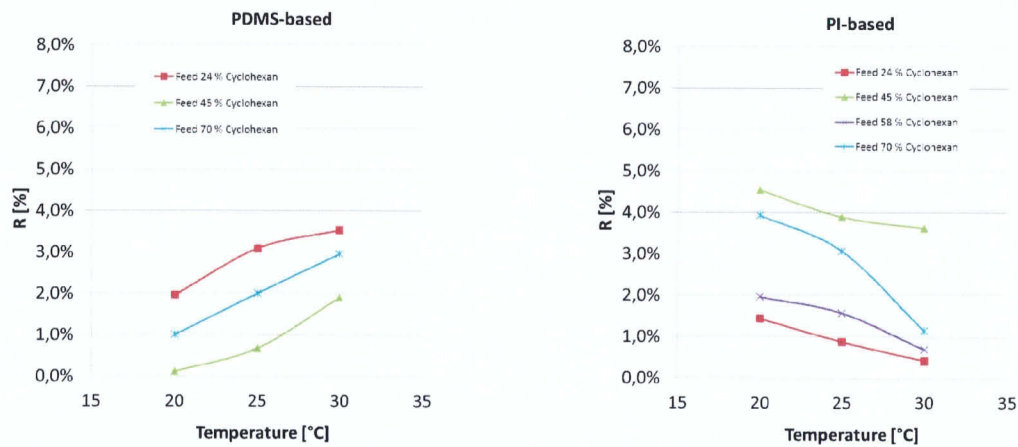

Figure 5: Correlation between Temperature and Retention (Cyclohexane)

3.2 Ethanol/2-Butanone

Again the results for the best performing PDMS-based membrane are compared to the results for the best PI-based one. In Figure 1 and 2 one can find the correlations for Pressure/Flux and Temperature/Flux. Figures 3 and 4 show the correlation for Temperature/Retention (EtOH) and Pressure/Retention (EtOH).

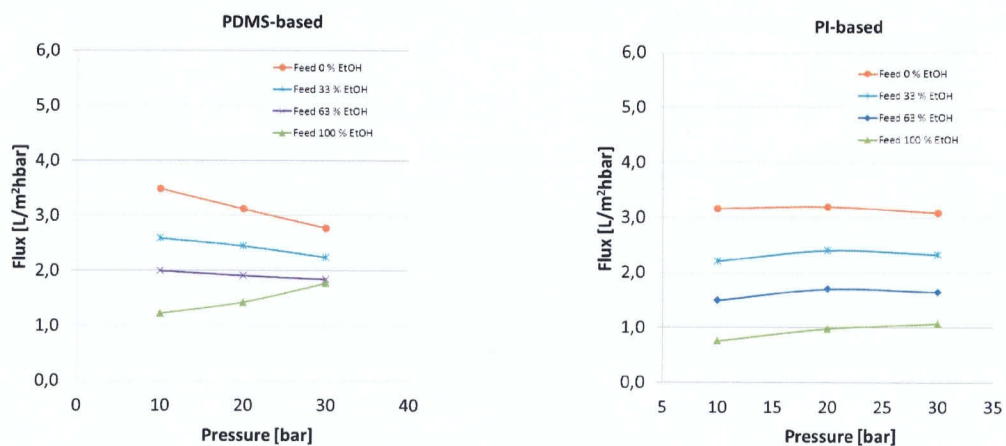

Figure 6: Correlation between Pressure and Flux

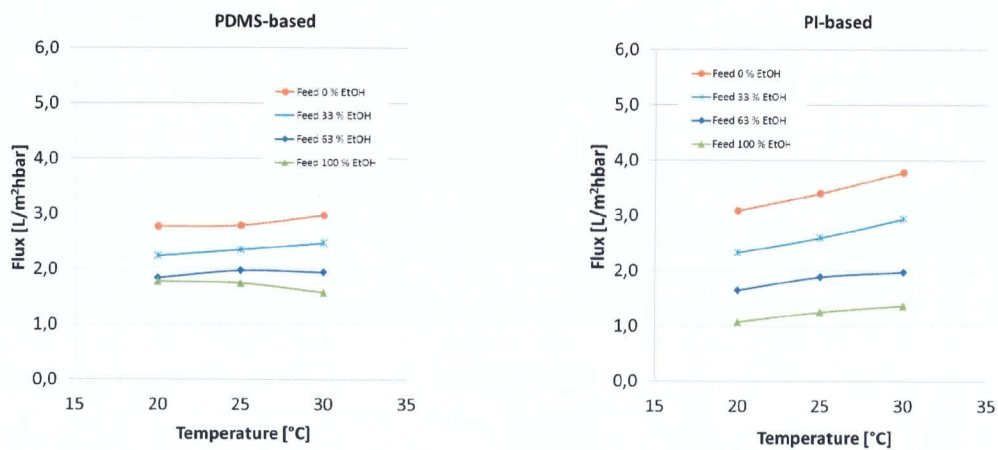

Figure 7: Correlation between Temperature and Flux

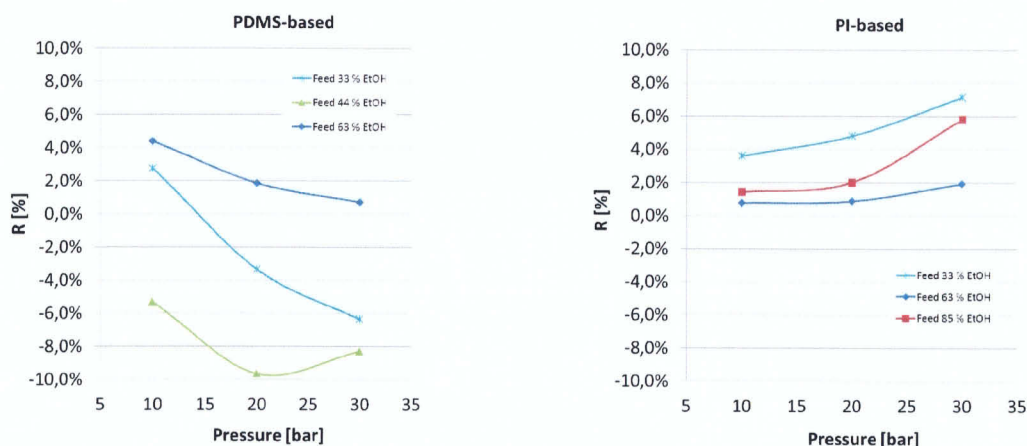

Figure 8: Correlation between Pressure and Retention (EtOH)

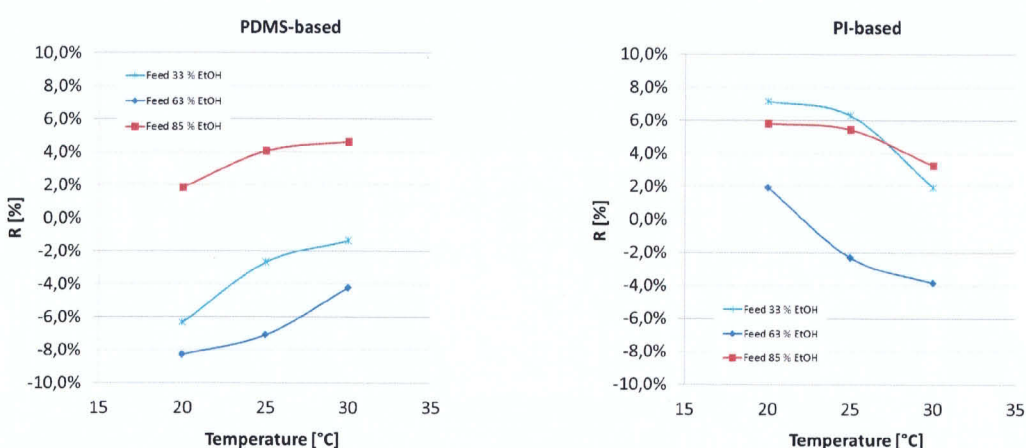

Figure 9:- Correlation between Temperature and Retention (EtOH)

4. Conclusions

As we compare the stable performances of different manufacturers' membranes for the separation of binary solvent systems at different conditions it can be shown that besides the differences amongst the membranes' materials, the feed compositions as well as the operating parameters play a major role for the obtained separation performance (flux and retention). Depending on the investigated solvent mixture different membrane materials cope very differently with changing parameters as some show positive correlation to temperature and pressure rise whereas others behave in the opposite way. This can be of great importance when designing a modern separation process using ONF to recycle used solvents to increase energy efficiency.

References

- Bhanushali D., Kloos S., Kurth C., Bhattacharyya D., Journal of Membrane Science 2001, 189, 1.
 Ebert K., Koll J., Dijkstra M.F.J., Eggers M., Journal of Membrane Science 2006, 285, 75.
 Koseoglu S.S., Lawhon J.T., Lusas E.W., Journal of American Oil Chemists' Society, 1990, 67, 315–322.
 Lide R., CRC Handbook of Chemistry and Physics, 78th edition, 1997, New York.
 Raman L.P., Cheryan M., Rajagopalan N., Journal of American Oil Chemists' Society, 1996, 73, 219–224.
 Schmidt M., Mirza S., Schunert R., Rodicker H., Kattanek S., Malisz J., Chemie Ingenieur Technik, 1998, 71, 199.
 Silva P., Han S., Livingston A. G., Journal of Membrane Science 2005, 262, 49.
 Stamatialis D.F., Stafie N., Buadu K., Hempenius M., Wessling M., Journal of Membrane Science 2006, 279, 424.
 Yang X.J., Livingston A.G., Freitas dos Santos L., Journal of Membrane Science, 2001, 190, 45–55.