

Electrostatic Ignition Hazards Associated with the Pneumatic Transfer of Flammable Powders through Insulating or Dissipative Tubes and Hoses

Martin Glor^{*a}, Carsten Blum^b, Wolfgang Fath^c, Claus-Diether Walther^d

^aSwissi Process Safety GmbH, WRO-1055.5.27, CH-4002 Basel

^bDEKRA EXAM GmbH, Dinnendahlstr. 9, D-44809 Bochum

^cBASF SE, GCP/RS - L511, D-67056 Ludwigshafen

^dBayer Technology Services GmbH, BTS-OSS-PPS-SE, D-51368 Leverkusen
martin.glor@swissi.ch

When transferring powder through pipes or hoses made from insulating material, propagating brush discharges cannot be excluded. To calculate the limit value of the resistivity of the insulating material, below which no propagating brush discharges will occur, the charging current due to the powder transfer must be known. This charging current has been determined experimentally. Based on analytical calculations and computer models limit values for the resistivity of the hose material are derived from these experiments.

1. Introduction

Pneumatic transfer of powders or granules through pipes, tubes or hoses is well known to be one of the processes giving rise to the highest build-up of static electricity in industry. As soon as at least one part - the product or the equipment - is insulating, charge build-up occurs. In fixed installations usually metal pipes are used, which are reliably connected to earth. If highly insulating products are transferred through such pipes, the charge build-up on the pipes is immediately released to earth and no electrostatic ignition hazard related to pipes exists. The charged product is transferred into a receiving silo or container, where it may generate very high electrical fields and provoke discharges, but that is not the topic of the present investigation.

If however, e.g. for reasons of handling and manipulating the transfer line, the transfer line must be flexible, often tubes or hoses mainly made from plastics are used. Many different constructions are presently on the market, where the insulating material may also be combined with dissipative or conductive materials and structures (e.g. a plastics hose with a metal spiral within the wall). Such tubes or hoses may give rise to brush discharges mainly on the outer side of the tubes and hoses, spark discharges at the outer or inner side of the tubes and hoses, if the tubes and hoses contain conductive material that is not properly grounded such as e.g. a metal spiral and propagating brush discharges if the tubes and hoses are made of insulating or a combination of insulating and dissipative or conductive materials.

The occurrence of propagating brush discharges during the pneumatic transfer of powders through hoses made from insulating material with an earthed metal spiral embedded in the wall has been observed in industry. Furthermore, Pavey (2009) demonstrated in experiments the formation of propagating brush discharges in such hoses and in similar geometrical arrangements. According to the German guidelines on the avoidance of ignition hazards due to static electricity TRBS 2153 (2009), it is therefore required to use dissipative material for the inner part of the hose, in which the earthed metal spiral is embedded. Since - according to these guidelines - a dissipative property can be achieved by limits for the surface resistance as well as for the volume resistivity and the corresponding upper limits are 10^{11} Ohm (at 23°C and 30% rh)

or $10^9 \Omega\cdot\text{m}$ respectively, there existed qualified doubts, whether these limits are low enough to exclude propagating brush discharges under realistic conditions.

In order to correctly specify the requirements to exclude the occurrence of these discharges from such tubes and hoses, it is important to know the charging current running to and through the inner surface of the hose during the powder transfer. If this charging current is known, either the potential or the surface charge density build up at the inner surface of the hose wall can be calculated or estimated by computer simulations. If either the potential stays below 4 kV or the surface charge density stays below $2.5\cdot 10^{-4}\text{C}/\text{m}^2$ no propagating brush discharges will occur, as specified in the relevant guidelines CLC TR 50404 (2003), TRBS 2153 (2009) and IEC 60079-32-1 (2012). Therefore, for the purpose of setting up reliable specifications of the volume resistivity limits of the material of the hose wall, experiments have been performed with a vacuum suction system. In these experiments the charging current running to and through the inner surface of the hose during the powder transfer has been measured under different conditions.

2. Experimental set-up and results

The test setup is shown in Figure 1 and a typical hose with a metal spiral embedded in a plastic wall is shown in Figure 2. The bulk material is sucked from a hopper through the hoses under test to the suction unit of a PTS (powder transfer system). The hoses were divided into several sections by cutting the wire spiral. Each section and the suction unit were connected to charge meters consisting of a capacitor and a high impedance voltmeter. The charge from each charge meter was recorded. For each segment the resulting current densities have been calculated, compared and analysed. The hose or tube type, the diameter, the transferred type of product as well as the flow velocities (amount of air mixed to the product flow) have been varied.

The maximum current density measured in these experiments was $164 \mu\text{A}/\text{m}^2$. More details about the experimental set up and data collection can be taken from a paper by Fath et al. (2013). For reasons of safety a current density of $1 \text{ mA}/\text{m}^2$ has been chosen for all further considerations and calculations representing a safety factor of about 6.

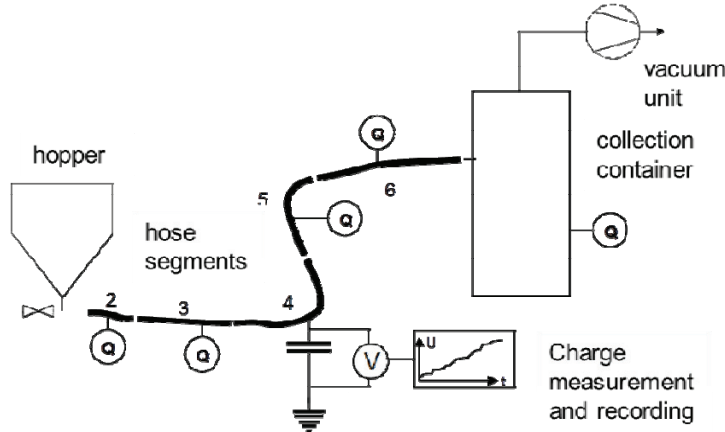

Figure 1: Experimental set up for the measurements of the charging current of the pipes and hoses due to pneumatic powder transport.



Figure 2: Example of a transfer hose with a metal spiral embedded in plastic wall

3. Calculations of the potential distribution along the inner surface of the hose wall

3.1 Hose with homogeneous wall

If the wall of the hose is made of a homogeneous material with a volume resistivity ρ , length L , wall thickness D , a constant current density i flowing to the inner surface and the hose is earthed at $x = 0$, the potential along the hose $U(x)$ can be described analytically in an easy way by the formula

$$U(x) = i \cdot \rho / (D \cdot (L - x - 0.5 \cdot x^2)) \quad (1)$$

The potential is proportional to the current density i and to the resistivity ρ of the wall material. In the example of Figure 3 the resistivity of the wall material is $10^4 \Omega\cdot\text{m}$, thus just at the border from conductive to dissipative, the wall thickness is 5 mm and the length of the hose is 10 m, one end is grounded and the other end free. With a current density of 1 mA/m^2 the potential at the free end will be 100 kV. The resistance to ground at the end is $1.27 \cdot 10^8 \Omega$. Brush discharges as well as spark discharges will occur.

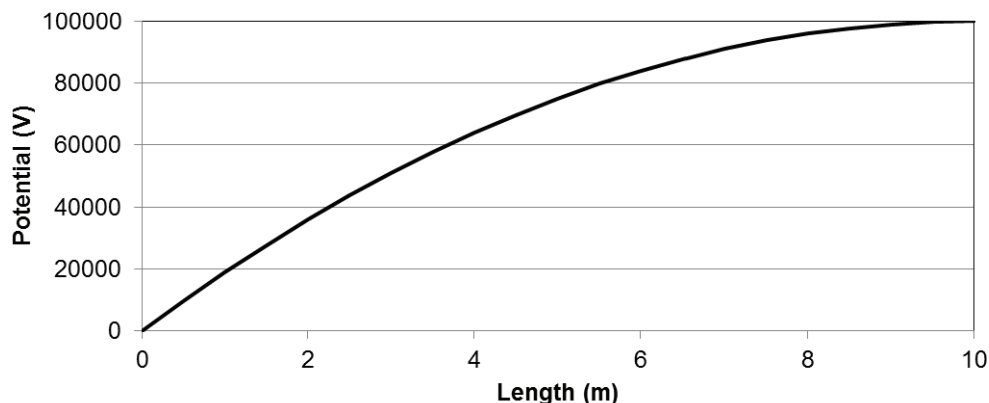

Figure 3: Potential as a function of hose length for a homogeneous hose with resistivity of the wall material $10^4 \Omega\cdot\text{m}$, thus just at the border from conductive to dissipative and wall thickness 5 mm. One end is grounded and the other end free. With current density of 1 mA/m^2 the potential at free end will be 100 kV.

3.2 Hose with a conductive wall on the outside and an insulating or dissipative inner layer

If the wall of the hose is made of two different layers, the outer layer conductive with a conductivity like metals and grounded and the inner layer dissipative or insulating the potential and the surface charge density at the surface of the inner wall can be calculated quite easily.

With area A , layer thickness of insulating or dissipative layer D , resistivity of insulating or dissipative layer ρ , resistance $R = \rho \cdot D/A$, current I and current density to the inner surface $i = I/A$, the potential across the insulating or dissipative layer is

$$U = R \cdot I = \rho \cdot i \cdot D \quad (2)$$

This wall design is prone to propagating brush discharges if the resistivity of the inner layer is too high. In Figure 4 the relation between material resistivity of the dissipative layer and the layer thickness is plotted for the 4 kV threshold potential of propagating brush discharges and different charging currents.

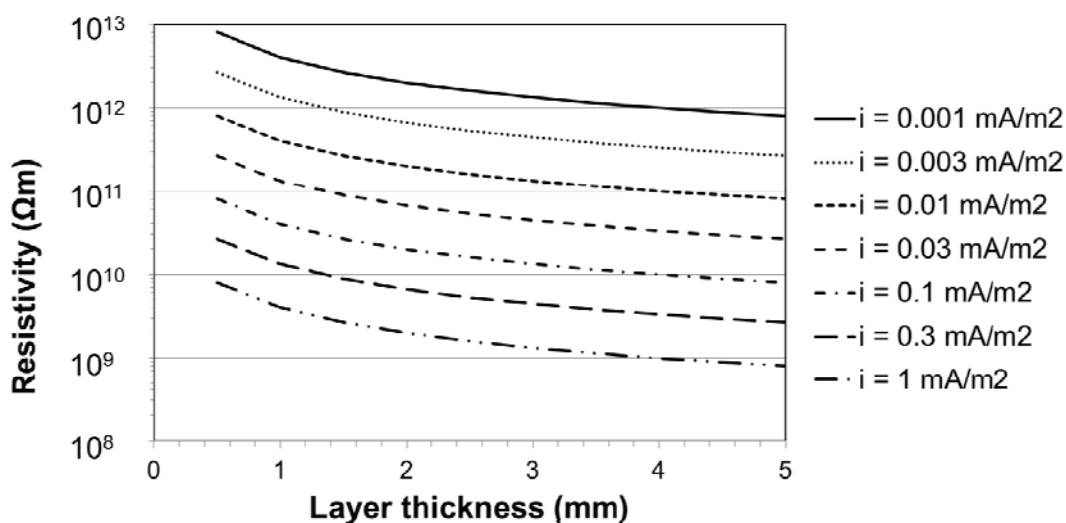

Figure 4: Material resistivity of the dissipative layer as a function the layer thickness and different charging currents based on the 4 kV threshold potential limit for the occurrence of propagating brush discharges.

From Figure 4 it can be derived, that – based on the 4 kV threshold criteria - for a hose with an outer conductive and earthed layer and an inner dissipative layer the resistivity of the dissipative layer must not be larger than about $2 \cdot 10^9 \Omega \cdot m$ in case of a charging current of 1 mA/m^2 and a layer thickness of 2 mm.

Based on the threshold criterion of the surface charge density of $2.5 \cdot 10^{-4} \text{ C/m}^2$, another relationship between the resistivity of the dissipative layer and the charging current can be derived as follows:

With area of the inner wall A , layer thickness of insulating or dissipative layer D , total charge on the inner wall Q , permittivity of the vacuum ϵ_0 , relative permittivity of the material of the inner layer ϵ , capacitance $C = \epsilon_0 \cdot \epsilon \cdot A/D$, surface charge density at the inner surface $q = Q/A$ and potential at the inner surface $U = Q/C = Q/(\epsilon_0 \cdot \epsilon \cdot A/D) = q/(\epsilon_0 \cdot \epsilon/D)$, the relation

$$\rho = q/(i \cdot \epsilon_0 \cdot \epsilon) \quad (3)$$

can be derived by taking into account equation (2). Figure 4 shows this relationship for different relative permittivities of the dissipative layer.

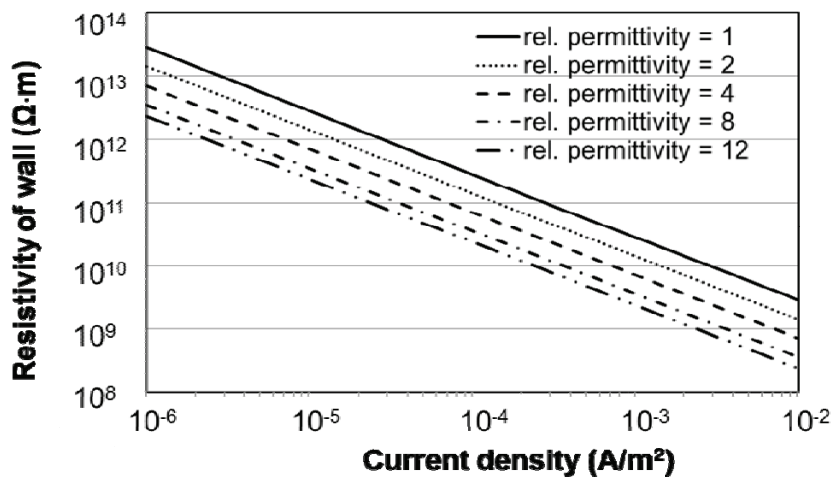

Figure 4: Material resistivity of the dissipative layer as a function of the charging current for different relative permittivities of the dissipative layer based on the surface charge density limit of $2.5 \cdot 10^{-4} \text{ C/m}^2$ for the occurrence of propagating brush discharges.

For a relative permittivity of 8 and a charging current of 1 mA/m^2 the same upper limit of about $2 \cdot 10^9 \Omega \cdot m$ for the resistivity of the dissipative layer is obtained for the avoidance of propagating brush discharges as with the 4 kV criterion.

The different results obtained for the different criteria (4 kV limit and $2.5 \cdot 10^{-4} \text{ C/m}^2$ limit) to prevent propagating brush discharges are due to the fact, that both of these limits are not dependent on the layer thickness, whereas both quantities are influenced differently by the layer thickness, when they are correlated with the charging current density, as can be seen when comparing and analysing equations (2) and (3).

3.3 Hose with metal spiral embedded in the wall with and without a conductive layer on the outside

For a hose with a metal spiral embedded in the dissipative layer the equations can no longer be solved analytically. Therefore the calculation of the potential distribution along the inner surface of such a hose has been performed on a 64 bit HP EliteBook 8460p Laptop with the software COMSOL Multiphysics® Version v4.3.

The model calculations have been performed under the following assumptions:

- The hose is made from a dissipative material with a volume resistivity of $10^9 \Omega \cdot m$.
- The wall thickness is 6 mm.
- The external Radius of the hose is 20 mm.

- The spiral is made from metal and has a radius of 1 mm.
- The spiral is located within the dissipative wall at a distance between 1 mm and 3 mm from the inner surface (distance between spiral surface and inner wall surface).
- The height of one turn of the spiral is varied between 23 mm and 28 mm.
- The length of the model hose is 200 mm.
- The metal spiral is earthed.
- The conductive layer on the outside is earthed (if present at all).
- The charging current is 1 mA/m^2 .

Figure 5 shows the geometry of the model hose and Figures 6 and 7 show examples for the surface potential distribution along the inner wall of the hose in axial direction.

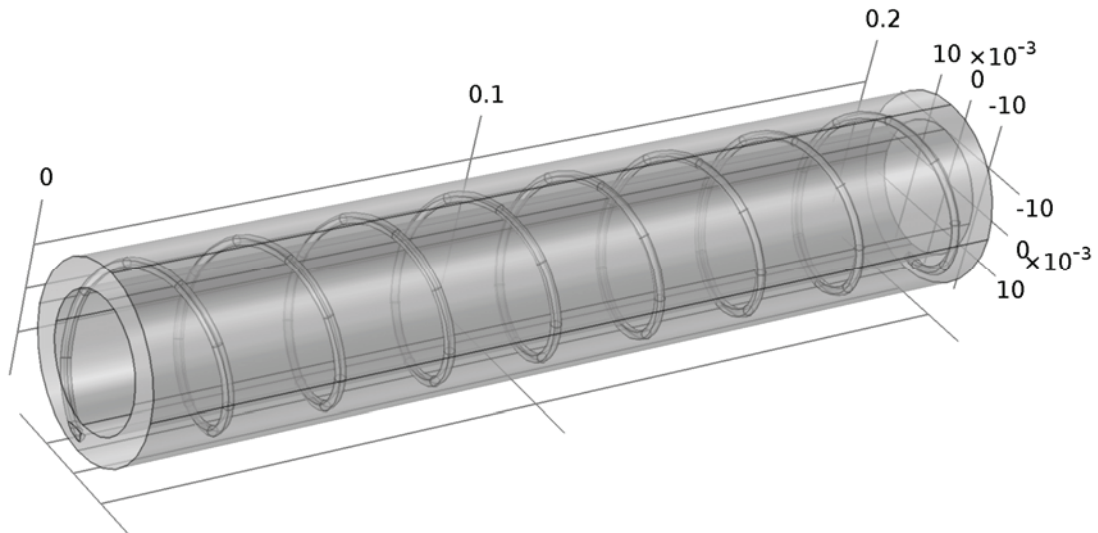

Figure 6: Geometry of the hose used for the model calculations.

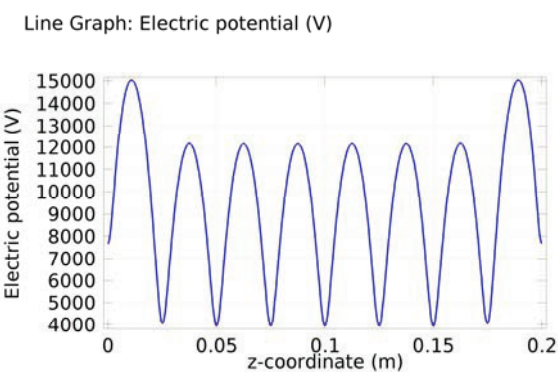

Figure 6: Surface potential at the inner wall in axial direction for 2 mm thickness between spiral surface and inner wall and 25 mm height of one turn of the metal spiral, without a conductive layer on the outside.

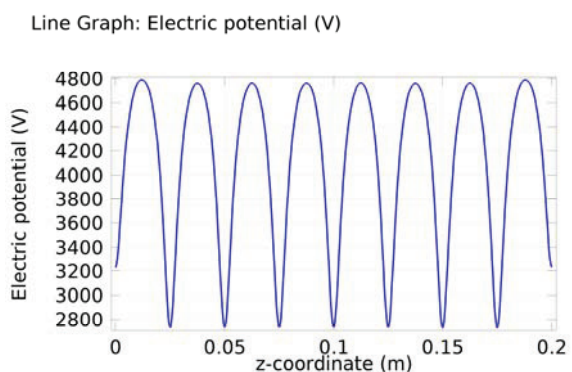

Figure 7: Surface potential at the inner wall in axial direction for 2 mm thickness between spiral surface and inner wall and 25 mm height of one turn of the metal spiral, with an earthed conductive layer on the outside.

Based on the model calculations and the definitions:

- Potential of the inner surface at places opposite to the spiral = U_s
- Potential at places in between two spiral turns U_i

The following characteristics can be derived:

- The surface potential along the inner wall is directly proportional to the resistivity of the dissipative layer
- The surface potential along the inner wall is directly proportional to the current density entering the surface of the inner wall.
- There is a large difference between U_S and U_I independent on whether there is an earthed conductive wall on the outside of the hose or not, as can be seen in Figures 6 and 7.
- The potential U_S as well as the potential U_I is strongly influenced by the presence of an earthed conductive layer on the outside of the hose, as can be seen by a comparison of Figure 6 with Figure 7.
- Within a range from 1 mm to 3 mm the potential U_S is more or less directly proportional the distance between spiral surface and inner wall surface independent on whether there is an earthed conductive wall on the outside of the hose or not.
- Within a range from 1 mm to 3 mm the potential U_I does practically not depend on the distance between spiral surface and inner wall surface independent on whether there is an earthed conductive wall on the outside of the hose or not.
- Within a range from 23 mm to 28 mm the height of one spiral turn has practically no influence on U_S and U_I , if there is an earthed conductive wall on the outside of the hose
- Within a range from 23 mm to 28 mm the height of one spiral turn there is a moderate influence on U_S and U_I , if there is no earthed conductive wall on the outside of the hose.

4. Conclusions

Propagating brush discharges can be excluded in hoses with earthed metal wires if the wire is embedded in a material of sufficiently low volume resistivity. The requirements for the volume resistivity can be derived by computer model calculations for the given geometrical arrangement. For example a hose with a wall thickness of 6 mm, an external radius of 20 mm, a metal spiral with a wire radius of 1 mm and a height per turn of 25 mm placed 2 mm from the inner surface, the resistivity must not be higher than $3.3 \cdot 10^8$ Ohm·m without an earthed conductive external layer and the resistivity must not be higher than $8.3 \cdot 10^8$ Ohm·m with an earthed conductive external layer.

References

- CLC/TR 50404 CENELEC Technical Report „Electrostatics - Code of practice for the avoidance of hazards due to static electricity”, June 2003.
- Fath W., Blum C., Glor M. and Walther C.-D., 2013 to be published in the Journal of Electrostatics, 2013.
- IEC 60079-32-1, Technical Specification EXPLOSIVE ATMOSPHERES – Part 32-1: Electrostatic hazards, Guidance, Draft August 2012.
- Pavey I.D., 2009, Propagating brush discharges in flexible hoses, Journal of Electrostatics 67, 251-255.
- TRBS Technical rules plant safety 2153 „Avoidance of ignition sources due to static electricity”, Germany, June 2009.