

## TRAM: a New Quantitative Methodology for Tunnel Risk Analysis

Marco Derudi<sup>a</sup>, Fabio Borghetti<sup>b,\*</sup>, Simone Favrin<sup>a</sup>, Alessio Frassoldati<sup>a</sup>

<sup>a</sup>Politecnico di Milano, Dip. di Chimica, Materiali e Ingegneria Chimica "G. Natta", P.zza L. Da Vinci 32, 20133, Milano, Italy

<sup>b</sup>Politecnico di Milano, Dip. di Design, Laboratorio Mobilità e Trasporti, Via Durando 38/A, 20154, Milano, Italy.

[fabio.borghetti@polimi.it](mailto:fabio.borghetti@polimi.it)

The paper illustrates and describes the structure of a new quantitative model of risk analysis for road tunnels named TRAM (Tunnel Risk Analysis Model). The result of the model, in accordance with the European Directive and the Italian Legislative Decree, returns the F-N curves of societal risk, in other words functions that relate the frequency of occurrence of an accidental scenario (F) with the expected consequences in terms of potential victims (N).

Starting from two types of initial events, a fire and a Dangerous Goods (DG) release, a total of 18 accidental scenarios was defined. The frequencies of occurrence of each accidental scenario is obtained using the Event Tree Analysis (ETA) technique. For each scenario, the number of fatalities, expressed in terms of deaths, is obtained by simulating the formation dynamics of the queue of vehicles, using a model able to calculate the queue length, depending on traffic, the vehicle type, as well as the closure time of the tunnel. Then, a distribution model of the potentially exposed users has been defined and coupled with an egress model. The users' tenability is estimated on the basis of the egress model and the evolution of each accidental scenario, which is evaluated using a zone model. The proposed model can simulate each of the 18 accidental scenarios in several different positions along the tunnel, considering the impact that different tunnel infrastructure measures, equipment and management procedures can have on the users egress and on the propagation of the effects of the accidental scenarios. The model is able to consider the interdependence between these measures and their reliability in terms of their availability in an emergency situation. Finally, to validate the model, comparisons are made with the QRAM software developed by PIARC for some representative case studies. Through this model, it is possible to perform the risk analysis of a tunnel in an actual configuration and compare the expected value of damage with the corresponding one of the tunnel in a virtual configuration, as prescribed by the Italian decree compliant with the European Directive 2004/54/EC.

### 1. Introduction

Some severe tunnel fires in Europe, such as those of the Mont Blanc, Gotthard and Tauern tunnels, have clearly displayed the dramatic urgency of adapting the road and rail tunnels to higher safety standards (Tavelli et al., 2013). Fires in tunnels are a threat not just for the safety of users but also for rescue teams (Borghetti et al., 2017). These issues push public authorities and tunnel designers to take increasing account of risks connected with fires. For a given accidental scenario, the set of consequences and their magnitude depend in turn on the instruments and mitigation actions started at the tunnel design and management levels, and involve the following factors: human behaviour, structural solutions, technological systems, management and control procedures.

The process of evacuation from a tunnel in emergency conditions is a complex phenomenon that involves different factors, tied to both physical characteristics such as the tunnel geometry or the distance between the emergency exits, and human behaviour. The evacuation time is mainly influenced by the users' speed during evacuation and by their pre-movement time which is the time required for occupants to identify the fire and respond to it (Lovreglio et al., 2015, 2016). Finally, the user safety is influenced by the effects of the accidental event, such as the propagation of toxic gases and reduced visibility, as the user movement speed can reduce dramatically in cases of reduced visibility and in the presence of harmful gas (Fridolf et al., 2013). In addition, the presence of systems such as emergency ventilation can have a positive effect on movement speed,

Please cite this article as: Derudi M., Borghetti F., Favrin S., Frassoldati A., 2018, Tram: a new quantitative methodology for tunnel risk analysis, *Chemical Engineering Transactions*, 67, 811-816 DOI: 10.3303/CET1867136

slowing the development of smoke in the tunnel. Additionally, safety measures such as firefighters or firefighting systems, or devices capable of closing the tunnel and reducing the number of exposed users (including panels, signs and loudspeakers able to inform and direct the users towards safety areas) are of significant importance. A comprehensive risk analysis model has to include the potential effect of all these measures (both technical and operational) and their interdependence. In this way it is possible to evaluate the effectiveness of each measure. The analysis can support the decision of the tunnel managers by identifying the optimal strategies and investments for maximizing tunnel safety.

## 2. Model Structure

TRAM is a comprehensive quantitative risk analysis model for road tunnels considering plant, infrastructure and management measures prescribed by EU Directive 2004/54/EC on minimum safety requirements for tunnels in the Trans-European Road Network. The risk assessment is done through the evaluation of F-N curves (Frequencies of accidental scenarios - Number of fatalities) and the comparison with the ALARP (*As Low As Reasonably Practicable*) criterion of acceptability.

The frequencies of the different accidental scenarios are obtained through an event tree analysis, starting with the frequency of the initial accidental events. The number of fatalities, expressed in terms of deaths, is obtained by simulating the formation dynamics of the queue of vehicles, using a model able to calculate the queue length, depending on traffic, the vehicle type, as well as the closure time of the tunnel. Then, a distribution model of the potentially exposed users has been defined and finally an egress model, to compare the evacuation time of users with their maximum residence time in the tunnel. The model is able to consider the reliability of the safety measures of the tunnel in terms of their availability in an emergency situation. In addition, it is assessed the interdependence between the various measures in order to represent their contribution in the users evacuation process. Figure 1 shows the logical structure of the TRAM model.

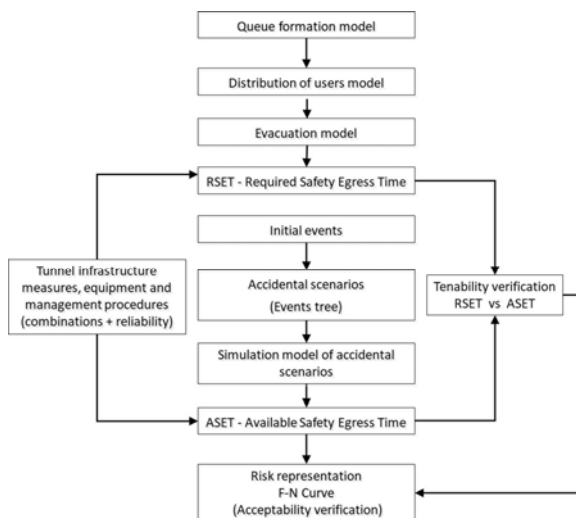

Figure 1: Logical outline of the implemented Tunnel Risk Analysis Model (TRAM)

### 2.1 Event tree analysis and frequencies of occurrence of accidental scenarios

The model takes into consideration two initial events, a fire and a DG spill, characterised by an initial occurrence frequency,  $F_{fire}$  and  $F_{rel}$ . These events are typical, and representative of the tunnel system intended as a confined environment. Table 1 shows the estimated Heat Release Rate (HRR) associated with the difference categories of vehicles and DG release events. The reported values represent the maximum fire intensity that can be reached for each fire scenario. Using the event tree, the model is currently able to analyze 14 accidental scenarios, 5 of which are associated with fire and 9 with DG release. Additional fire HRRs (4 MW, 25 MW, 80 MW and 100 MW) are considered in the case of mitigation measures such as the automatic fire extinguishing system or suppression system that can reduce the fire intensity. In this case the total number is 18. In fact, the model assumes that the presence of the mitigation systems is able to reduce the HRR of the smaller fires of ~50 %. Therefore, the 15 MW scenario is included in the 8 MW one.

As an example, Figure 2 illustrates an event tree that gives the different scenarios  $SC$  with associated frequency  $F_s$ , starting from the initial frequency of the fire event  $F_{fire}$ .

Table 1: Accidental scenarios: HHR associated with the initial fires and final scenarios related to a DG release

Initial event	N. accidental scenario	Accidental scenario SCs	Description
Fire	1	F1	Fire LV1, Q= 8 MW
	2	F2	Fire LV2, Q= 15 MW
	3	F3	Fire HV1, Q= 50 MW
	4	F4	Fire HV2, Q= 100 MW
	5	F5	Fire DGV, Q= 150 MW
DG release	6	R1	Pool-fire (relevant spill)
	7	R2	Pool-fire (small spill)
	8	R3	Jet-fire/BLEVE (liq+vap)
	9	R4	Toxic dispersion (gas, relevant)
	10	R5	Toxic dispersion (vapors, relevant)
	11	R6	Jet-fire (gas)
	12	R7	Jet-fire (gas/vapors)
	13	R8	VCE/Flash-fire (gas)
	14	R9	VCE/Pool-/Flash-fire (liq+vap)
The following additional accidental scenarios and HRR are considered only in case of presence of automatic fire extinguishing systems or suppression systems. The scenario corresponding to the 15 MW LV2 is included in the 8 MW.			
	15	F6	Fire LV1, Q= 4 MW
	16	F7	Fire HV1, Q= 25 MW
	17	F8	Fire HV2, Q= 80 MW
	18	F9	Fire DG, Q= 120 MW

The calculation model predicts that the *s*-th scenario can occur at different points in the tunnel: in this manner, it is hypothesised that the source of the initial event can be located in a generic position as a percentage of the total length of the tunnel *L<sub>tot</sub>*. A minimum of 6 positions is considered, as indicated in Figure 3.

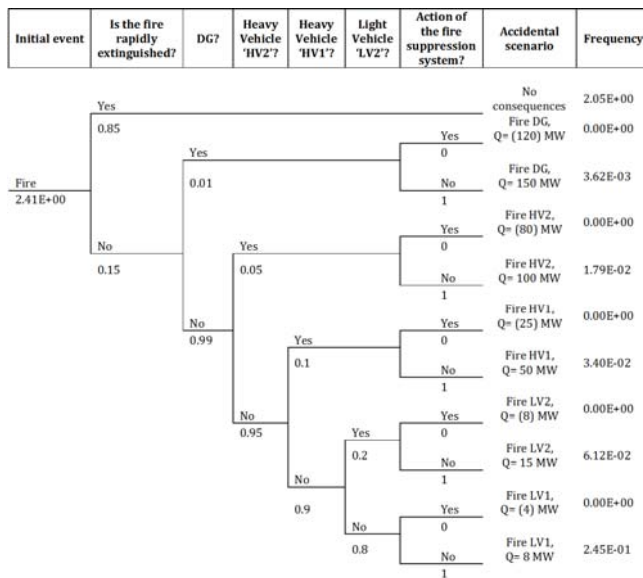

Figure 2: Example of an event tree related to the initial fire event

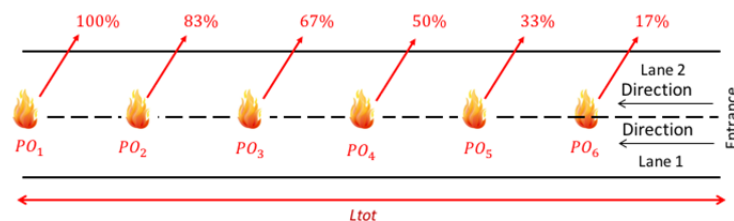

Figure 3: Examples of positions at which the accidental scenario can occur (tunnel with unidirectional traffic)

**2.2 Tunnel infrastructure measures, equipment and management procedures**

The model considers the total number of tunnel infrastructure measures, equipment and management procedures that can be present in a specific tunnel under investigation. Each measure influences a specific model parameter. For example, the presence of a mechanical ventilation system and emergency lighting influence the user egress speed. The measures can also influence the frequencies of occurrence  $F_s$  of the accidental scenarios in the event tree. Further examples of measures considered in the model are the presence of flammable liquid drainage, water supply system, specialised rescue team, control centre, event automatic identification cameras, traffic lights at the tunnel entrance, GSM coverage, emergency stations, evacuation lighting, etc.

**2.3 Queue formation model**

Using this sub-model, it is possible to simulate the formation of queues of vehicles in the tunnel by evaluating the position of the vehicles and their stopping times. The model gives the length along which the queue of vehicles extends in each  $i$ -th lane from the accident to the tunnel entrance. Estimation of the queue length is needed to evaluate the number of users potentially involved by the event and their egress routes. The queue model takes into account the traffic flow and compositions and the possible presence of devices able to close the tunnel and their activation times, as indicated in Figure 4.

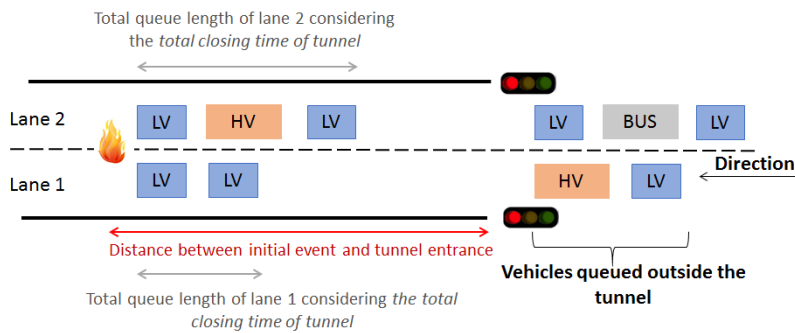

Figure 4: Representation of partial tunnel filling in presence of effective measures for tunnel closing

**2.4 Development of accidental scenarios and users' egress model**

After having estimated (thanks to the queue formation model) the number of users present in the tunnel and potentially exposed to the event, the egress of the users is evaluated using a uniform distribution for each  $i$ -th lane, as sketched in Figure 5.

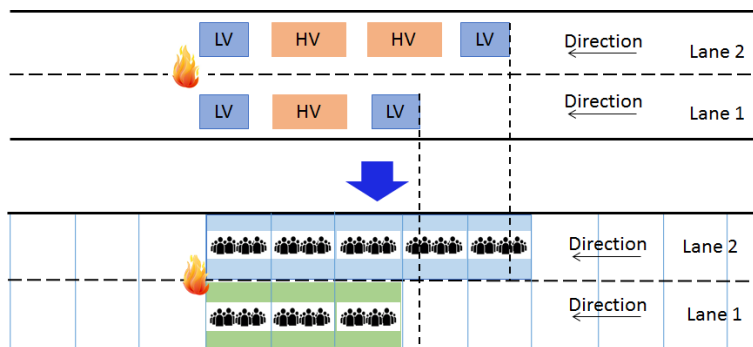

Figure 5: Identification of the cells through which the queue in each lane is discretized

The uniform distribution allows lane discretization using cells. For each user, the escape route consists of the distance that he has to cover in order to move to a safe zone (shelter), reach the entrance/exit of the tunnel or use the available emergency exits and/or bypasses. However, the egress of the users is affected by the evolution of each accidental event. Of course, a recognition and pre-movement time, which includes the time to leave the vehicle, is considered for each user, which is a function of safety measures such as the presence of loudspeakers, variable message signs, etc. As an example, Figure 6 shows the development of a fire

scenario inside a ventilated tunnel using CFAST, a two-zone fire model able to calculate the evolving distribution of smoke, fire gases and temperature throughout the tunnel or a building during a fire (Tavelli et al., 2014). Each accidental scenario influences the egress of the users, because of a reduction of egress speed due to reduced visibility in presence of smoke and may cause deaths because of heat and smoke toxicity effects. This is evaluated dynamically for each user along his escape trajectory.

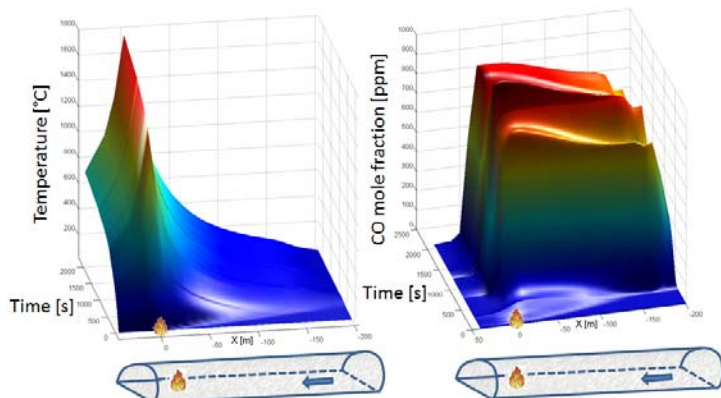

Figure 6: Example of fire consequences evolution inside a ventilated tunnel calculated with CFAST

In general, the procedure for the evaluation of users' tenability considers two steps:

- Verification of tenability of the users during pre-movement time;
- Verification during the egress process to the closest emergency exit.

### 2.5 Calculation of the F-N curve and the expected damage value

Using TRAM, it is possible to estimate the total number of fatalities (N) inside the tunnel for each *s*-th scenario, and each *p*-th position; the estimate considers the matrix of all the possible combinations with the system, infrastructure and management measures. A case study is used to present the F-N curve of a one-way tunnel.

### 3. Case Study: F-N curve calculated by TRAM and comparison with QRAM software

In order to further verify the model, the results were compared using QRAM software for several tunnels (ranging from 900 m to 4500 m) and possible accidental scenarios. It should be considered, however, that the selectable tunnel infrastructure measures, equipment and management procedures of the two models are not easy to compare.

This comparison is believed to be useful for verifying qualitative trends and the position of the F-N curves. QRAM is a Quantitative Risk Assessment Model software developed jointly by PIARC (Permanent International Association of Road Congresses) and OECD (Organisation for Economic Cooperation and Development) for estimating the risk in tunnels and considers 13 accidental scenarios.

Table 2: Main characteristics of Tunnel 1

Parameter	Value
Length [m]	910
Section [m <sup>2</sup> ]	54
Number of lanes	2
Distance between the emergency exits [m]	500
ADT [vehicles/day]	5623
Peak time flow when the analysis was carried out [vehic/h]	562 (10 % ADT)
Longitudinal slope [%]	+3.4
Average number of people in a light vehicle [n. people/vehicle]	2
Average number of people in a heavy vehicle [n. people/vehicle]	1.1
Average number of people in a bus [n. people/vehicle]	30
Percentage of light vehicles [%]	85
Percentage of heavy vehicles [%]	14
Percentage of buses [%]	1
Average speed of the light vehicles [km/h]	110
Average speed of the heavy vehicles/buses [km/h]	70

One representative unidirectional tunnel is selected for comparison in this work. Table 2 presents the main characteristics of the tunnel and Figure 7 shows the comparison in terms of F-N curve between the proposed model (TRAM) and the QRAM software. Despite the difficulty due to the different approaches of the two models, the F-N curves are in reasonable agreement. The same result was observed for longer tunnels.

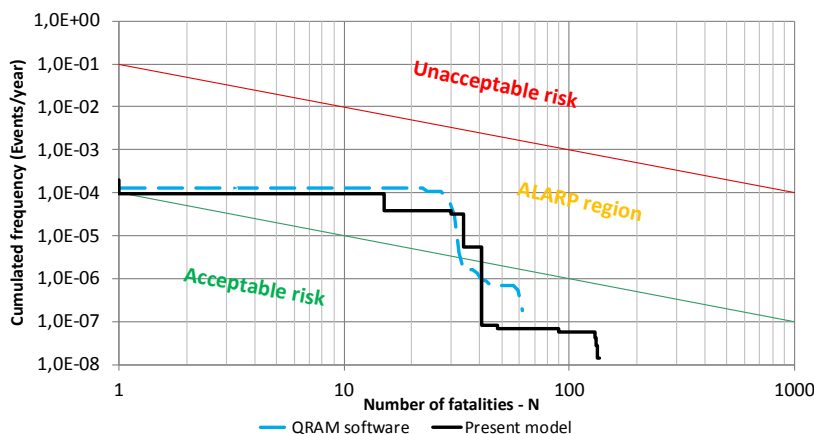

Figure 7: F-N curves from present model, TRAM, and QRAM software for a tunnel with length 910 m and Average Daily Traffic (ADT) 5623 vehicles/day

## Conclusions

This paper illustrates and describes the structure of a new quantitative model of risk analysis for road tunnels named TRAM. The model, in accordance with the legislation requirements, calculates the F-N curves of societal risk, by evaluating the frequency of occurrence of different accidental scenarios (F) and their expected consequences in terms of potential victims (N: number of fatalities). Starting from two initial events, a fire and a DG release, 18 accidental scenarios are evaluated. The frequencies of occurrence of each scenario analysed were obtained using the Event Tree Analysis (ETA) technique. The consequences are evaluated on the basis of a sub-model for the formation of a queue of vehicles in the tunnel and a sub-model for evacuation that evaluate users' tenability during egress. For each of the 15 tunnel measures that can be selected by the analyst, the model can consider their reliability, hypothesizing that each selected measure could be, due to failure, eventually unavailable at the moment of need. A probabilistic parameter of reliability for each of the measure is defined to account for the failure possibility, thus generating a large number of combinations ( $2^{15}$ ). Moreover, considering 18 accidental scenarios (9 fires and 9 DG releases) and a minimum of 6 possible positions along the tunnel, the model analyses up to 3 million total cases for a single tunnel. The calculation procedure has been automatized, in order to reduce execution time and the possibility of errors. Finally, to validate the model, comparisons were made with the QRAM software developed by PIARC for three representative tunnels. The comparison confirmed the validity and consistency of the proposed model.

## References

- Borghetti F., Derudi M., Gandini P., Frassoldati A., Tavelli S., 2017, Tunnel Fire Testing and Modeling: The Morgex North Tunnel Experiment, Springer International Publishing, DOI:10.1007/978-3-319-49517-0.
- Fridolf K., Ronchi E., Nilsson D., Frantzich H., 2013, Movement speed and exit choice in smoke-filled rail tunnels, *Fire Safety Journal*, 59, 8-21
- Lovreglio R., Ronchi E., Nilsson D., 2015, A model of the decision-making process during pre-evacuation, *Fire Safety Journal*, 78, 168–179
- Lovreglio R., Ronchi E., Nilsson D., 2016, An Evacuation Decision Model based on perceived risk, social influence and behavioral uncertainty, *Simulation Modelling Practice and Theory*, 66, 226–242.
- GRAM - Quantitative Risk Assessment Model software, <[www.piarc.org/en/knowledge-base/road-tunnels/qram\\_software/](http://www.piarc.org/en/knowledge-base/road-tunnels/qram_software/)> accessed 17.04.2018
- Tavelli S., Derudi M., Cuoci A., Frassoldati A., 2013, Numerical analysis of pool fire consequences in confined environments, *Chemical Engineering Transactions*, 31, 127–132
- Tavelli S., Rota R., Derudi M., 2014, A critical comparison between CFD and zone models for the consequence analysis of fires in congested environments, *Chemical Engineering Transactions*, 36, 247-252