

Multivariable Decoupling Compensator for a Tank Level Control

Maja Atanasijević-Kunc, Rihard Karba, France Bremšak

Faculty of Electrical and Computer Engineering, Ljubljana, Slovenia

As multivariable systems are usually quite complex some possible simplifications of nonlinear model of three coupled tanks are presented in the paper. Well known decoupling method is combined with classical design and finally improved with so called conditioned technique which can always be realised if decoupling is possible. The simplification is so dual. This approach enables the use of design methods for univariable systems but can also be very helpful when switching between automatic and manual control is needed, especially when combined with anti-windup method known as conditioned technique. We believe that in process industry there are many cases where this solution can be successfully used. Some other possibilities still under development are also indicated.

Introduction

Usual situation in multivariable control system design is that classical analysis and design methods for single-input, single-output (SISO) systems which would fulfil all design goals are not applicable due to the cross coupling between input and output variables. This goals are expressed specially in process industry with terms like stability, good reference tracking and disturbance rejection, robustness to model uncertainties, safe and probably bumpless transfer between automatic and manual control, etc.

One possible approach of solving such situations is an attempt to reduce or eliminate cross coupling in such a manner that use of classical methods is then possible on resulting subsystems. If such diagonal dominance or decoupling is achieved, one can control each output of the

system only with the corresponding input. But in spite of this situation we have to point out, that decoupling doesn't mean, that control signals of the plant are independent. This is of course a very important fact as this signals have to operate inside of the prescribed limitations. However their dynamics is usually also the measure of energy consumption and therefore it is desired to keep their absolute and effective value as small as possible.

Mentioned problems are illustrated through the nonlinear multivariable model of three coupled tanks, which often can be found as a subsystem in process industry. Paper is organized as follows. First the plant is described in terms of normal operating values. Then nonlinear mathematical model and linearized approximation is derived. Good reference tracking and disturbance rejection is achieved by the combination of decoupling compensators and univariable PI-controllers in the following section in such a manner that in addition classical transfer from automatic to manual control can be used on each decoupled subsystem separately. Further improvements of the closed loop behaviour are obtained through the use of so called conditioned technique or anti-windup method for which it is shown that in combination with decoupled system it is always possible to find out a solution.

As numerical algorithms for multivariable systems are usually very complex, the need for suitable computer aided support is also impor-

tant. For solving the described problem we have used program package MATLAB (with SIMULINK and some toolboxes) where all additional operations were realized in the form of so called m-functions.

Some concluding remarks and ideas for further work are given in the end of the paper.

Model description

Schematic representation of the plant under consideration together with some important operating data are shown in Fig. 1.

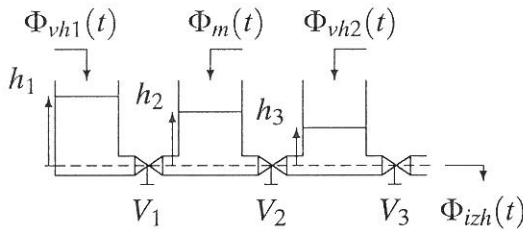

$$\begin{aligned}
 S &= 1.54m^2 \\
 \bar{h}_1 &= 0.4m, \quad \bar{h}_2 = 0.3m \\
 \bar{h}_3 &= 0.2m, \quad h_{imax} = 0.6m \\
 \bar{\Phi}_{vh} &= 0.18m^3/h, \quad \Phi_{mmax} = 0.18m^3/h
 \end{aligned}$$

Fig. 1. Schematic representation of three coupled tanks.

The system consists of three cylindric coupled tanks with cross area S . We would like to control the level of the liquid in the first ($h_1(t)$) and the third ($h_3(t)$) tank through input flows $\Phi_{vh1}(t)$ and $\Phi_{vh2}(t)$. There is a possibility to measure the levels in all three tanks and normal flows (in steady state) are chosen to be in the middle of the operating area. The normal values of other variables are given in Fig. 1 (overlined). The height of each tank equals 0.6m. System operating is from time to time disturbed with the flow $\Phi_m(t)$ but it is not greater then $0.18m^3/h$. Mathematical model of the system can be described with the following equations:

$$\begin{aligned}
 \frac{dh_1(t)}{dt} &= -\frac{K_1}{S}\sqrt{h_1(t) - h_2(t)} + \\
 &+ \frac{1}{S}\Phi_{vh1}(t) \\
 \frac{dh_2(t)}{dt} &= \frac{K_1}{S}\sqrt{h_1(t) - h_2(t)} - \\
 &- \frac{K_2}{S}\sqrt{h_2(t) - h_3(t)} + \\
 &+ \frac{1}{S}\Phi_m(t) \\
 \frac{dh_3(t)}{dt} &= \frac{K_2}{S}\sqrt{h_2(t) - h_3(t)} - \\
 &- \frac{K_3}{S}\sqrt{h_3(t)} + \\
 &+ \frac{1}{S}\Phi_{vh2}(t)
 \end{aligned} \quad (1)$$

where valve constants K_i can be evaluated from steady state operating point. In our case they are found to be: $K_1 = 0.5692$, $K_2 = 0.5692$, $K_3 = 0.8050$. It is well known, that nonlinear relations in (1) can be approximated by the use of Taylor's series, so that linear state space model can be derived for the neighbourhood of the steady state as follows:

$$\begin{aligned}
 \underline{\dot{x}} &= \underline{A}\underline{x} + \underline{B}\underline{u} + \underline{E}\underline{z} \\
 \underline{y} &= \underline{C}\underline{x}
 \end{aligned} \quad (2)$$

where in our case matrices \underline{A} , \underline{B} , \underline{C} and \underline{E} are found to be:

$$\begin{aligned}
 \underline{A} &= \begin{bmatrix} -0.5844 & 0.5844 & 0 \\ 0.5844 & -1.1688 & 0.5844 \\ 0 & 0.5844 & -1.1688 \end{bmatrix}, \\
 \underline{B} &= \begin{bmatrix} 0.6494 & 0 \\ 0 & 0 \\ 0 & 0.6494 \end{bmatrix}, \\
 \underline{C} &= \begin{bmatrix} 1 & 0 & 0 \\ 0 & 0 & 1 \end{bmatrix}, \quad \underline{E} = \begin{bmatrix} 0 \\ 0.6494 \\ 0 \end{bmatrix}
 \end{aligned}$$

and

$$x_i = \Delta h_i, \quad u_i = \Delta \Phi_{vhi}, \quad z_2 = \Delta \Phi_m$$

where Δ denotes deviation from steady state. Simulated results proved good matching between nonlinear and linearized situation, so further design can be made on the basis of linear model.

Decoupling and classical closed-loop design

The comparison of both models gave also the following conclusions. The system contains cross coupling, which means that each of inputs affects all output variables and initial conditions of each state disturbe both outputs. Long lasting disturbance $\Phi_m(t) = 0.18m^3/h$ can cause decantation in the first and the second tank, which must of course be prevented by suitable chosen control action. Some additional analyses showed, that system properties enable the decoupling of the process on the basis of the following control law (Falb and Wolovich, 1967, Gilbert, 1969)

$$\underline{u} = \underline{F}\underline{x} + \underline{G}\underline{\omega} \quad (3)$$

where \underline{F} and \underline{G} are constant compensators of appropriate size. We have also some freedom in choosing the elements of \underline{F} so, that desired closed loop configuration can be achieved while the free parameters of \underline{G} were calculated to ensure the gain of each path to be 1. In our case the decoupling pair is:

$$\underline{F} = \begin{bmatrix} -0.8999 & -0.8999 & 0 \\ 0 & -0.8999 & 0 \end{bmatrix},$$

$$\underline{G} = \begin{bmatrix} 1.7998 & 0 \\ 0 & 1.7998 \end{bmatrix}$$

The results of this action proved to be very successful as it is now possible to control the outputs of the system quite independently without steady state error between new inputs $\underline{\omega}$ and outputs \underline{y} .

Also the disturbance rejection is quite good, but some steady state error could be in this case unavoidable, so in addition two univariable PI-controllers were added in each loop ($K_{Pi} = 1, K_{Ii} = 0.2$).

Here we can mention, that some other classical control structures can be also acceptable. But since the used decoupling compensator has changed the closed-loop poles to be faster than those from original system, the main control action of additional SISO controllers have to maintain the steady state error to zero.

Fig. 2 to 8 illustrate some characteristic behaviour of obtained closed-loop structure. In Fig. 2 and 4 the responses in all three tanks to step changes on the first (Fig. 2) and second (Fig. 4) reference signal are shown, while in Fig. 6 the responses to the disturbance (shown in Fig. 8) are illustrated. Fig. 3, 5 and 7 present corresponding (unlimited) control signals. We can see, that good behaviour is obtained in almost all cases.

The exception is of course the situation, represented in Fig. 5, where we can see, that the magnitude of the second reference signal after $t = 60[h]$ demands the second control signal to exceed the prescribed operating area. As actuator would not be able to realize such an action it saturates at upper limit and the result of such situation is shown in Fig. 9. Due to the so called wind-up effect this leads to very long settling time of the process. Such undesired behaviour can be (inside real possibilities) corrected by the use of so called conditioning technique as proposed by Hanus (1980, 1987).

Anti-windup compensation of decoupled system

In Fig. 10 the complete closed-loop structure of realized multivariable system is shown. Anti-windup (AW) methods, originally proposed by Aström and Wittenmark (1984), use states of controller to reduce the wind-up effect. Simple illustration of the problem in the case of univariable PI-controller is shown in Fig. 11.

Hanus (1980, 1987) has reformulated the problem in terms of 'realizable' reference signal. He has shown that in the case when K_a is chosen to be K_p , the states of the controller are updated in such a mannner that when the difference between the desired control variable and the actual control variable disappears, the closed-loop system reaches steady state with the same dynamics as the unconstrained closed-loop system. The

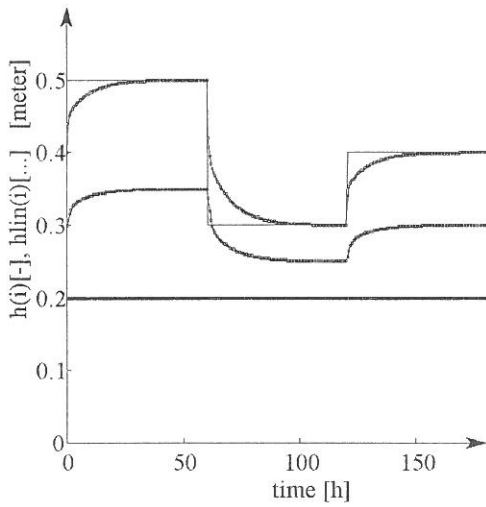

Fig. 2. Responses to ref. 1

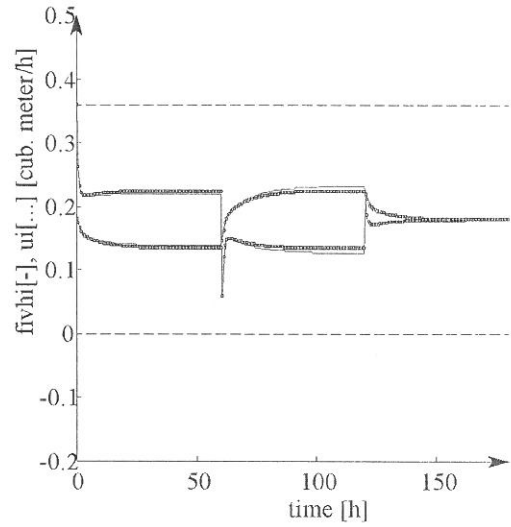

Fig. 3. Control signals to ref. 1

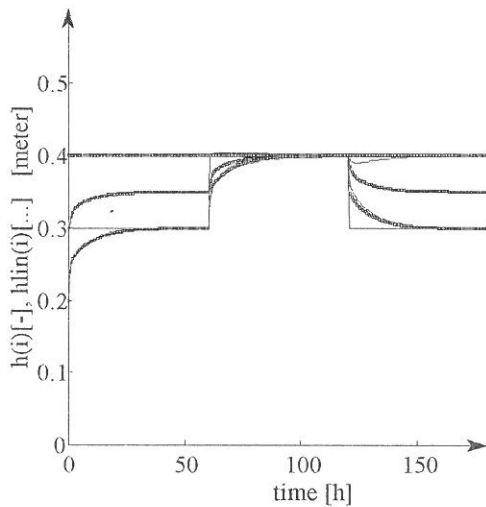

Fig. 4. Responses to ref. 2

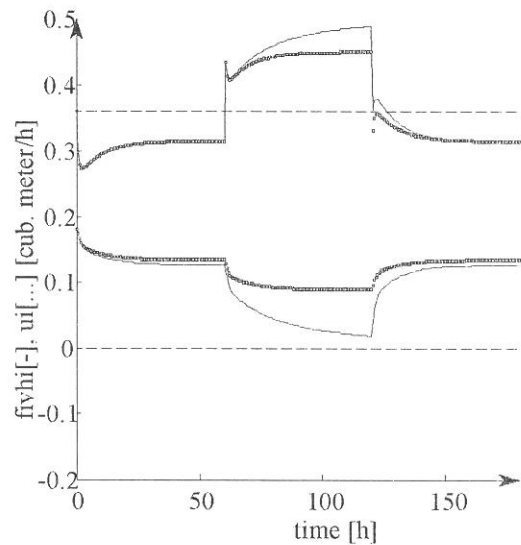

Fig. 5. Control signals to ref. 2

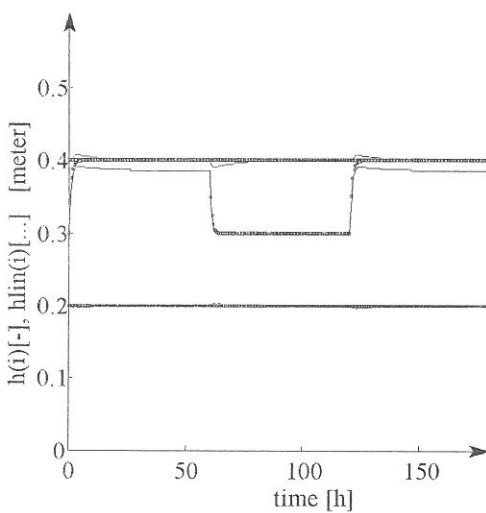

Fig. 6. Responses to disturbance

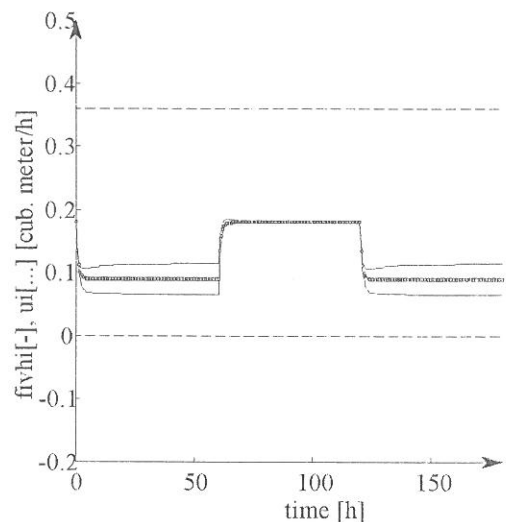

Fig. 7. Control signals to disturbance

theory can be extended to multivariable case (Hanus, 1987).

To use the idea in our configuration again the combination of univariable and multivariable case can be adopted. Comparing the situations in univariable case in Fig. 11 and multivariable configuration in Fig. 10 it can be seen that the first part of compensation can be the same as in univariable case (it means $\frac{1}{K_{Pi}}$ for each direct path), but as the constraints are not posed on \underline{w} but on \underline{u} which is the control signal of the system, the difference between \underline{u} and \underline{u}_l must be first multiplied by the \underline{G}^{-1} . The inverse of decoupling matrix \underline{G} always exists if decoupling is possible. The effect of such compensation is illustrated in Fig. 12 for the case from Fig. 9, while in Fig. 13 the corresponding control signals are presented.

From Fig. 12 and 13 we can conclude that such conditioned technique presents quite an improvement of system behaviour. It can't make of course the second output to reach the desired value between $t = 60$ to 120 [h], as control signal is not capable of such an action. The only solution for such a case would be an extension of operating possibilities of control action.

Conclusions

In the paper a combination of uni and multivariable design methods on nonlinear three coupled tanks is illustrated.

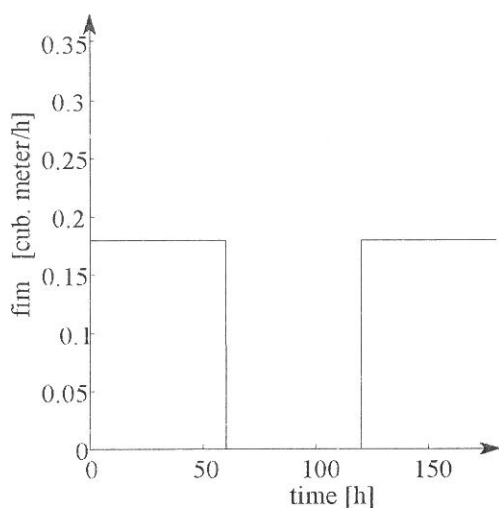

Fig. 8. Disturbance

First the system was decoupled with constant state feedback while final steady state behaviour was realized through two univariable PI-controllers. This structure enables very simple transfer from automatic to manual control as manual control can be successfully realized with decoupling compensators in the loop. Operator doesn't feel the multivariable nature of the system any more and can use each output from univariable controller independently.

Bumpless transfer from manual to automatic control is assured through suitable conditioned technique which can always be realized if decoupling is possible. Even in the case when system has weak inherent coupling, only additional dynamical precompensator is needed (Gilbert, 1968, Cremer, 1971), and the inverse matrix of compensated system has to be realized. For nontrivial systems such solution always exists.

With other multivariable structures which do not possess diagonal dominant or decoupled properties, opening of only one loop could be impossible due to stability problem which is in fact very similar to the integrity problem.

The solution of such a situation can be sometimes problematic if system states can not be measured directly. In such situations usually additional dynamics have to be incorporated into decoupling compensators. In the cases where diagonal dominance is sufficient we believe these complexity can be overridden so that complete

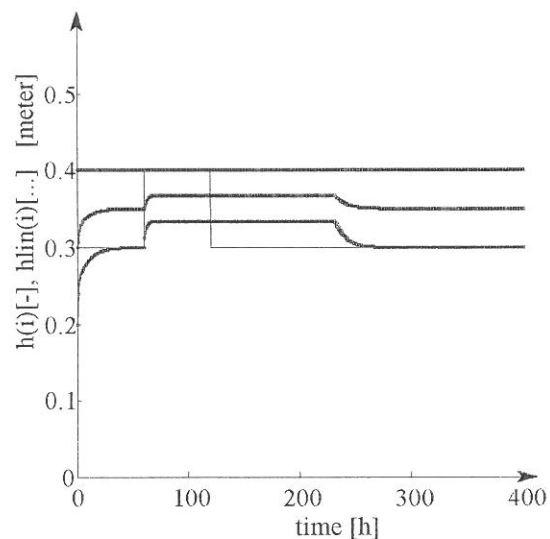

Fig. 9. Responses to ref. 2

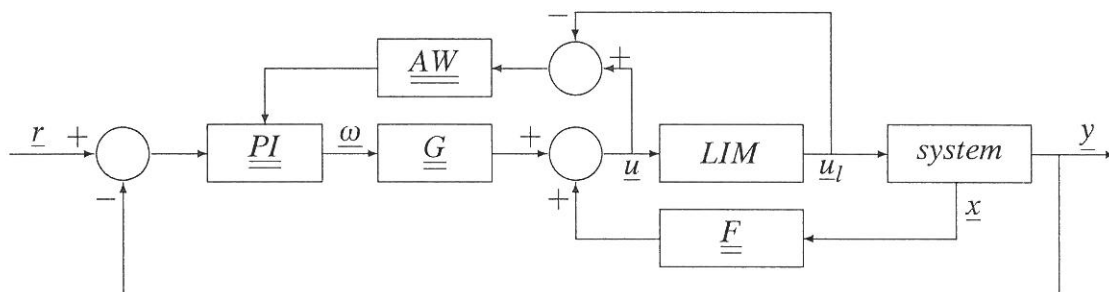

Fig. 10. Complete closed-loop realization.

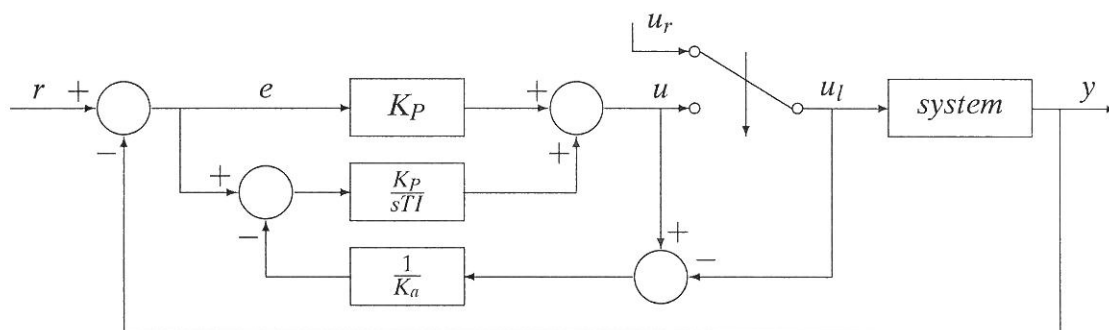

Fig. 11. The limited closed-loop univariable system with AW.

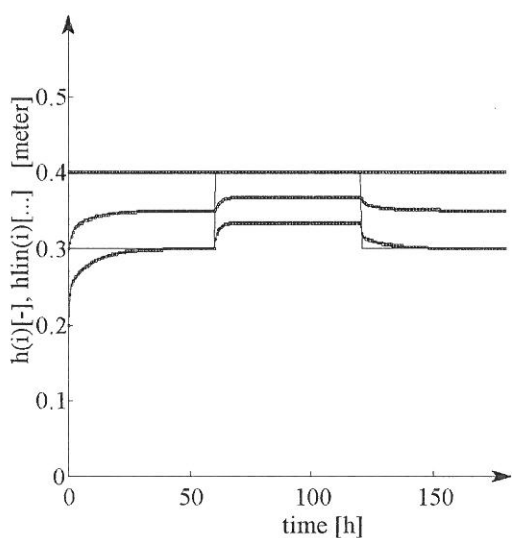

Fig. 12. Responses to ref. 2

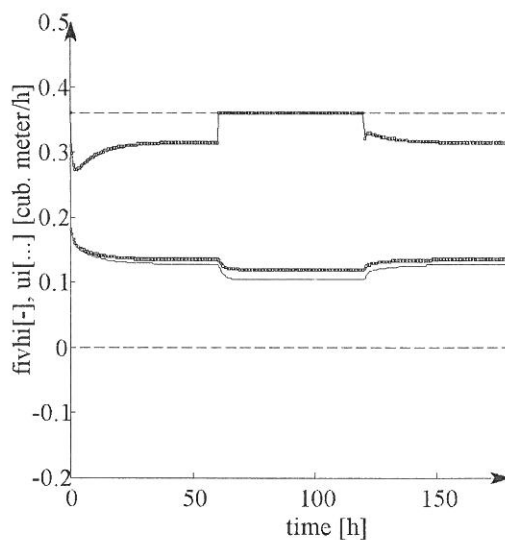

Fig. 13. Control signals to ref. 2

decoupling structure is approximated on the basis of known control signals (Atanasijević et al). This area is still under development together with possible AW compensator realization.

Received: October, 1994
Accepted: January, 1995

Contact address:

Faculty of Electrical and Computer Engineering
Tržaška 25
61000 Ljubljana, Slovenia
E-mail: maja.atanasijevic@ninurta.fer.uni-lj.si

References

- K. J. ÅSTRÖM, B. WITTENMARK (1984) *Computer Controlled Systems, Theory and Design*, Prentice Hall, Englewood Cliffs, New Jersey.
- M. ATANASIJEVIĆ, R. KARBA, F. BREMŠAK, T. RECELJ, J. GOLOB (1986) Comparison of Three Different Approaches to the Semibatch Distillation Column Control Design, Selected Papers from IFAC Symposium on Design Methods Control Systems, Zürich, Sep. 1991, ed. D. Franke and F. Kraus, pp. 231–236.
- M. ATANASIJEVIĆ, R. KARBA, B. ZUPANČIČ, F. BREMŠAK (1991) Combination of Methods in Multivariable Control Design, Preprints of the 1st IFAC Symposium on Design Methods Control Systems, Zürich, Sep. 1991, ed. D. Franke and F. Kraus, pp. 32–26.
- M. CREMER (1971) A precompensator of minimal order for decoupling a linear multivariable system, *INT. J. Control*, Vol. 14, No. 6, pp. 1089–1103.
- P. L. FALB, W. A. WOLOVICH (1967) Decoupling in the Design and Synthesis of Multivariable Control Systems, *IEEE Trans. on Autom. Control*, Vol. AC-12, No. 6, pp. 651–659.
- E. G. GILBERT (1969) The Decoupling of Multivariable Systems by State Feedback, *SIAM J. Control*, Vol. 7, No. 1, pp. 50–63.
- R. HANUS (1980) A new technique for preventing control windup, *Jurnal A*, Vol. 21, No. 1, pp. 15–20.
- R. HANUS, M. KINNAERT, J. L. HENROTTE (1987) Conditioning Technique, a General Anti-windup and Bumpless Transfer Method, *Automatica*, Vol. 23, No. 6, pp. 729–739.

FRANCE BREMŠAK received the Ph.D. in electrical engineering from the University of Ljubljana, Slovenia.

In 1976 he became full professor on the Faculty of Electrical Engineering, University of Ljubljana. He was responsible for the lectures of control systems and simulation. In 1992 he was retired but is still active as a mentor of M.Sc. and Ph.D. students.

RIHARD KARBA received the B.Sc., M.Sc. and Ph.D. degrees in electrical engineering, from the University of Ljubljana, Slovenia.

In 1977, he joined the Faculty of Electrical and Computer Engineering, University of Ljubljana, and in 1987 became Professor of automatic control, where he is currently responsible for lectures on: elements in automatic control, modeling of processes and multivariable systems (on undergraduate and graduate levels). His major research emphasis is in the fields of dynamical systems modeling and simulation, multivariable control design, and modeling and simulation in pharmacokinetics.

MAJA ATANASIJEVIĆ-KUNC received the B.Sc. and M.Sc. degrees in electrical engineering from the University of Ljubljana, Slovenia, in 1981 and 1984.

She is Teaching Assistant on the Faculty of Electrical and Computer Engineering, University of Ljubljana, Slovenia. Her research interests involve control of multivariable systems and simulation of dynamical systems.
