



## **Welding sequence effects on residual stress distribution in offshore wind monopile structures**

Ali Mehmanparast, Oyewole Adedipe, Feargal Brennan

*Offshore Renewable Energy Centre, Cranfield University*

*a.mehmanparast@cranfield.ac.uk, o.adedipe@cranfield.ac.uk, f.brennan@cranfield.ac.uk*

Amir Chahardehi

*Atkins Energy*

*amir.chahardehi@atkinsglobal.com*

---

**ABSTRACT.** Residual stresses are often inevitably introduced into the material during the fabrication processes, such as welding, and are known to have significant effects on the subsequent fatigue crack growth behavior of welded structures. In this paper, the importance of welding sequence on residual stress distribution in engineering components has been reviewed. In addition, the findings available in the literature have been used to provide an accurate interpretation of the fatigue crack growth data on specimens extracted from the welded plates employed in offshore wind monopile structures. The results have been discussed in terms of the role of welding sequence in damage inspection and structural integrity assessment of offshore renewable energy structures.

**KEYWORDS.** Welding sequence; Offshore wind monopole; Residual stress; Fatigue crack growth.

---

### **INTRODUCTION**

**W**elding is a metal joining process which is widely used in manufacturing of full scale components used in industrial applications. During the welding process inhomogeneous plastic strains, caused by thermal cycles (i.e. localised heating and cooling), are introduced into the material which subsequently lead to formation of residual (locked-in) stresses in the welded components. The extent of residual stresses in weldments can be quantified using different techniques. The non-destructive methods which are commonly employed to measure residual stresses are X-ray diffraction, for thin plates, and Neutron diffraction, for relatively thick geometries. It has been shown and discussed in previous studies by other researchers that compressive and tensile residual stresses play an important role in the fatigue crack growth behavior of cracked geometries (e.g. [1, 2]). Therefore, an important issue to be investigated and accounted for in the remaining life assessment of engineering components subjected to cyclic loading conditions is the influence of residual stresses on the fatigue crack growth behavior of welded components.

In order to assess the structural integrity of offshore renewable energy wind turbine structures, which are subjected to fatigue and corrosion damage during operation, fatigue crack growth (FCG) tests have been recently performed on fracture mechanics compact tension, C(T), specimens made of 355D steel which is the material commonly used in fabrication of offshore wind monopiles. C(T) specimens were extracted from typical monopile weldment sections, example of which is given in Fig. 1, with the notch tip located in the middle of the heat affected zone (HAZ) and tested

---

both in air and seawater. The specimen orientation for these tests was chosen in such a way to allow crack growth occurring in through-thickness (i.e. Y axis in Fig. 1) direction with the load applied along transverse (i.e. X axis in Fig. 1) direction. The preliminary results from these tests have shown “bi-linear”  $da/dN$  vs.  $\Delta K$  fatigue crack growth behavior [3] which is thought to be due to the tensile-compressive residual stress profiles introduced into the material during the welding process [4]. Neutron Diffraction (ND) measurements are therefore needed to be performed on weldments to provide accurate interpretation of the fatigue crack growth results. Large 355D plates with 90 mm thickness, from which C(T) specimens have been extracted, were welded using multi-pass double V-groove butt welding. The plates were pre-heated at 50-225°C and no post weld heat treatment was conducted. The parent plates were pre-strained through rolling and then welded, with the weld beads parallel to the rolling direction (i.e. along Z axis in Fig. 1). In this paper the experimental and numerical results available in the open literature have been reviewed to investigate the influence of welding sequence on residual stress fields for different engineering materials. The findings have been discussed in terms of the influence of multi-pass welding sequence on tensile-compressive residual stress fields and considered to investigate the preferred welding sequences for offshore wind turbine monopile structures.

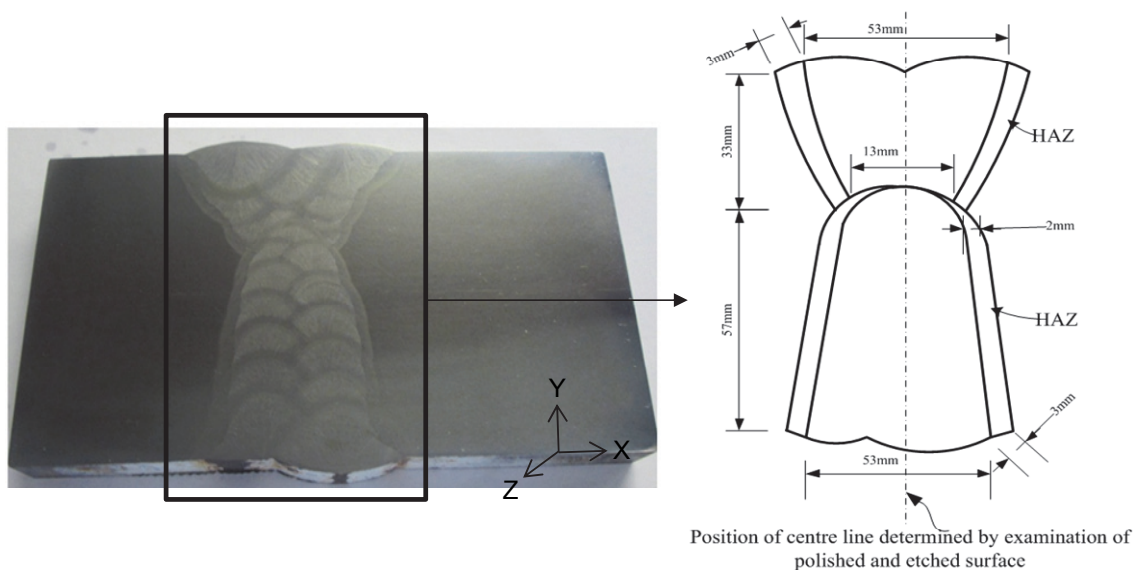

Figure 1: 90mm 355D steel weldment typical of an offshore wind monopile structure

## MULTI-PASS WELDING EFFECTS ON RESIDUAL STRESS FIELDS

### *Single V-Groove Welded Plates*

The experimental and numerical residual stress data available from studies carried out on single V-groove welded plates have been reviewed in this section. Experimental Neutron strain scanning measurements were performed by James MN et al [5] on RQT701 high strength steel welded plates manufactured using three different types of filler metals; under-matched, matched and over-matched. Two heat input values and plate thicknesses were used in multi-pass weld runs examined in this work (see Fig. 2). It has been shown in [5] that the heat input, filler metal yield strength, plate thickness and fusion zone shape influence the position and magnitude of the tensile and compressive residual stress peaks. An example of a welded plate examined in this work is shown Fig. 3. Also included in this figure are the indicative directions of residual stress components. The Neutron diffraction results plotted against “distance from centre of the weld” in [5] have shown that the Z-component (i.e. parallel to weld beads) of stress profile is tensile in the weld metal and HAZ material whereas the X-component (i.e. transverse) and Y-component (i.e. through-thickness) of stress profiles have been found to change from tensile to compressive and the measured values to vary as a function of the depth into the plate thickness (a function of Y coordinate). The residual strain measurement results plotted against “distance from center of the weld” in [5] show that the X-component (i.e. transverse) of micro-strain profile is strongly tensile in over-matched welded plates, however in those plates welded with under-matched filler metal both tensile and compressive transverse micro-strains have been found to have magnitudes of much lower than the tensile peaks observed in over-matched welded plates. Further shown in [5] is that the position of the tensile peak falls upon the region where the maximum weld



metal volume exists. Independent studies on welding residual stress measurements in multi-pass butt-welded austenitic stainless steel thick walled pipes presented in [6] and A36 structural steel thick plates shown in [7] confirm that the welding residual stress is severely sensitive to the yield strength of the weld metal.

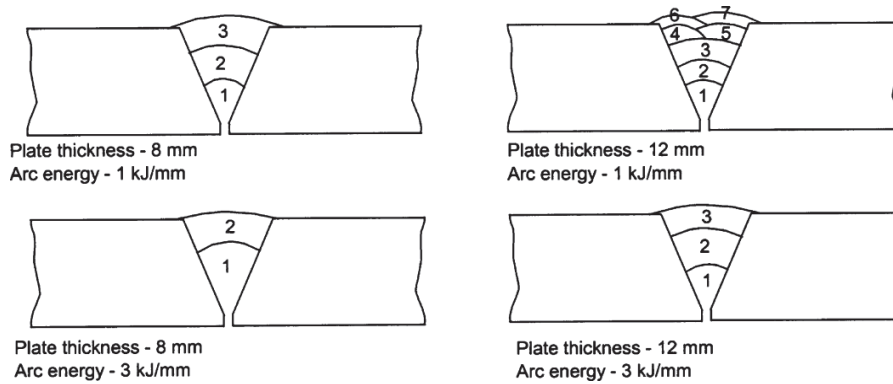

Figure 2: Different scenarios of multi-pass weld runs examined in [5].

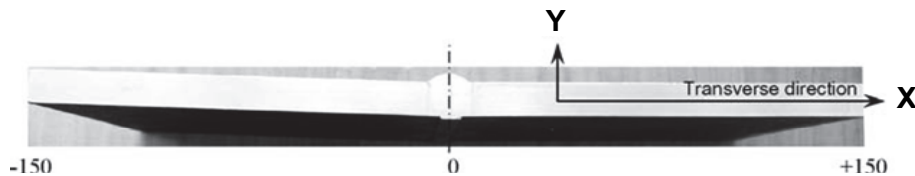

Figure 3: An example of a multi-pass welded plate.

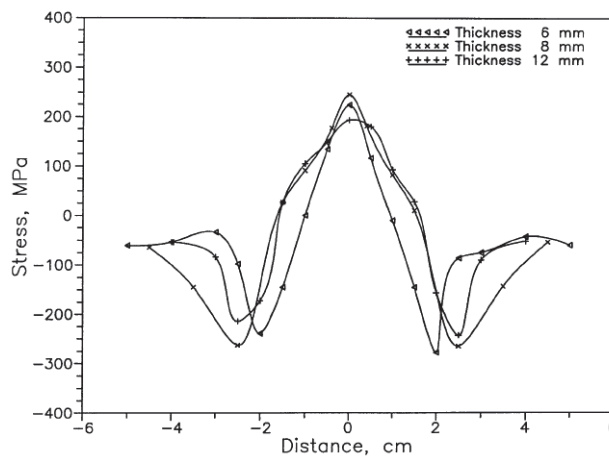

Figure 4: Illustration of the plate thickness effects on post-welding residual stress distribution in Type 304 stainless steel [8].

A similar study was carried out on AISI Type 304 stainless steel in [8] where thin plates during multi-pass Manual Metal Arc Welding (MMAW) process were measured using X-ray diffraction. It has been shown in [8] that by increasing the number of passes in single V-groove welded plates, the magnitude of peak tensile stress (at the centre of the weld) gradually reduces and increases on the root side and the top side of the weld pads, respectively. Also shown in [8] is that increasing the thickness of the weld pads leads to an increase in the extent of the residual stress distribution region and a reduction in the peak tensile residual stress values (see Fig. 4). Numerical studies of pass-by-pass residual stress predictions in thick walled plates and thick walled stainless steel pipes can be found in the published literature (e.g. [9, 10]). For instance a finite element study to predict maximum residual stresses in K and V type multi-pass weld joints before and after post weld heat treatment was carried out by Cho JR et al [10] in which the predicted results were validated through comparison with hole drilling measurements. It has been shown in [10] that the post weld heat treatment can reduce the maximum residual stress values by around 15%.



*Double V-Groove Welded Plates*

A numerical sensitivity analysis was carried out by Teng T-L [11] to investigate the influence of welding sequence on residual stress distribution in SAE 1020 thick plates. Two-dimensional finite element analyses were performed in this work to simulate various combinations of multi-pass butt welding sequence. As seen in Fig. 5, simulations were conducted to predict residual stresses induced in double V-groove welded plates for three different cases of welding sequences. In this study the V-grooves at both sides of the welded plates were assumed to be the same size. The predicted residual stresses from this study were plotted against “distance from the weld center” and the results are presented in Fig. 6. It can be observed in Fig. 6 that the stress trends and peak values are relatively sensitive to the welding sequence and the changes in residual stresses are more pronounced in transverse (along X axis) direction compared to the through thickness (along Y axis) direction. The predicted results in this figure show that the highest and the lowest peak tensile residual stresses were found in Case (C) and Case (A) of welding sequences, respectively. Comparing the transverse residual stress trends at the center of the weld region in Fig. 6(b) it can be seen that the residual stress value predicted for Case (C) is almost double of that of predicted for Case (A). Comparison of the residual stresses predicted in Fig. 6(a) and (b) shows that the through thickness (along Y axis) peak tensile residual stresses for all three cases of welding sequences have been found much larger than those of predicted along X direction. Finally seen in Fig. 6 is that the through thickness (along Y axis) residual stress trend shows tensile stresses near the weld bead and compressive stresses away from the weld bead, whereas no compressive residual stress field can be observed in transverse (along X axis) residual stresses.

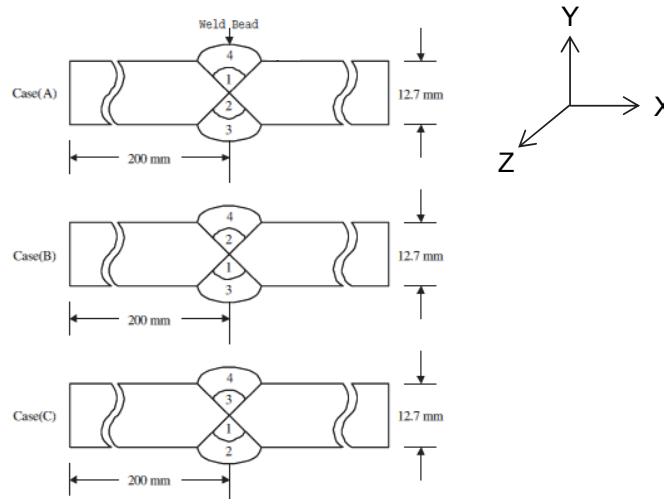

Figure 5: Different cases of multi-pass butt welding sequence [11].

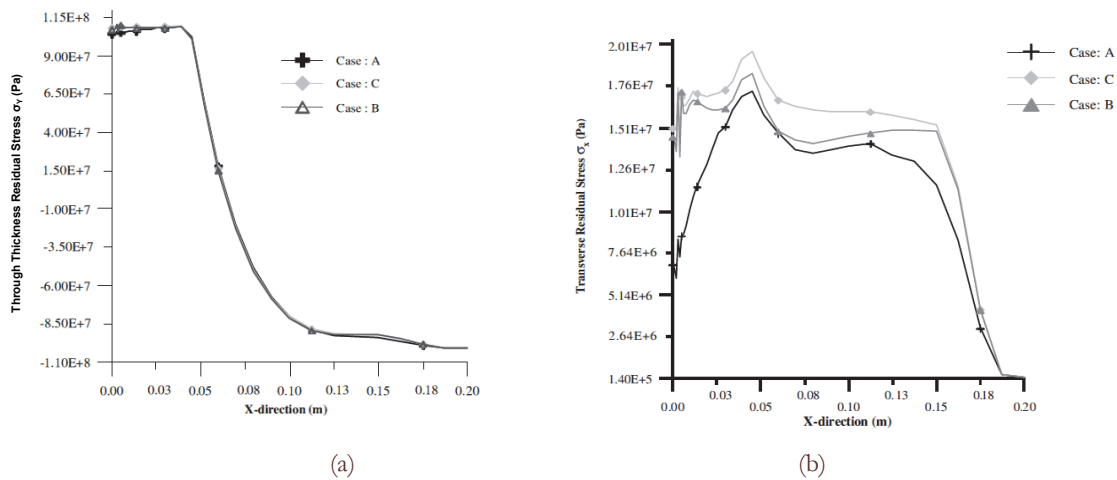

Figure 6: Predicted residual stress components along (a) Y direction (b) X direction , for three cases of welding sequences [11].



A similar numerical study on the welding sequence effects in multi-pass butt welding of double V-groove stainless steel thick plates has been conducted by Ji SD et al [12] in which finite element predications were validated through comparison with experimental data. A schematic illustration of the welding bead numbers and different cases of welding sequences considered by Ji SD et al [12] are shown in Fig. 7. As seen in Fig. 7 the bottom V-groove in this study was considered smaller than the top groove. It has been shown in [12] that the residual stress fields in the weld region are tensile for both through thickness (along Y axis) and transverse (along X axis) directions and the peak values were found near the center of the weld region. Finite elements simulations were conducted for different cases of the welding sequences shown in Fig. 7 and the peak residual stress results are summarized in Tab. 1. As seen in Tab. 1 the residual stress profiles and peak values were found sensitive to the welding sequence. Moreover, the numerical prediction results presented in [12] suggest that lower magnitude of residual stress profiles and peak values may be obtained when two V-grooves are evenly welded with filler metal (see case(e) and case (c) in Fig. 7).

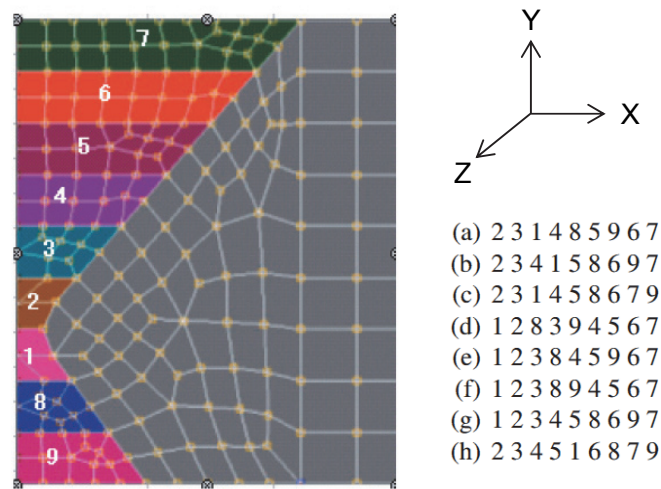

Figure 7: Illustration of welding bead numbers and sequences [12].

	Welding sequence							
	(a)	(b)	(c)	(d)	(e)	(f)	(g)	(h)
Transverse stress $\sigma_x$ (MPa)	623	544	405	718	505	511	829	857
Through thickness stress $\sigma_y$ (MPa)	634	636	507	823	592	607	879	865

Table 1: Predicted residual stress peak values for different cases of welding sequences [12].

## DISCUSSION

The residual stress measurements and finite element prediction results available in the literature have shown that the welding sequence has significant influence on the residual stress profiles and peak values in multi-pass butt welded plates. The numerical studies performed to predict residual stress profiles in double V-groove butt welded plates suggest that although transverse stresses may be more sensitive to the welding sequence, the through thickness component of residual stresses generally exhibit higher values compared to transverse stresses. This means that if the welded plate is subjected to a loading condition parallel to the through thickness direction, a relatively small percentage increase or decrease in the peak values of through thickness residual stresses, as a result of the change in the welding sequence, may lead to significant changes in crack growth behavior of the material. It has been also noted that the transverse peak stress values shown in Fig. 6(b) are much smaller than those of predicted in Tab. 1. The lower  $\sigma_x$  peak



values in Fig. 6(b) compared to Tab. 1 might be associated with uneven V-grooves in ref [12], different filler metal properties (e.g. over-matched, under-matched) employed in reference [11] and [12], etc. The peak transverse stresses in thick welded plates used in offshore monopiles (see Fig. 1) are expected to be closer to the values predicted in [12] and summarized in Tab. 1, though more finite element simulations need to be performed to investigate this further.

The residual stress measurement and prediction results for multi-pass welded plates available in the literature suggest that to improve the structural integrity of the offshore wind turbine monopile structures, suitable welding sequences which lead to lower values of damaging (i.e. tensile) residual stresses need to be employed in the fabrication processes. This will provide more robust and cost efficient offshore wind turbine structures. Moreover, by measuring the residual stress profiles in welded plates, the time required to inspect damage/cracks initiated in operating structures can be significantly optimized by prioritizing the inspection to be carried out on parts of the structure (e.g. inner surface or outer surface of an offshore monopile) containing tensile residual stresses as opposed to compressive stresses. In other words, in the parts of the offshore monopile welded structures that a tensile residual stress profile exists in a direction parallel to that of the dominant environmental loading axis, frequent inspection will be required since the chance of damage/crack initiation in this region is higher than anywhere else.

The fatigue crack growth results from the tests performed on HAZ C(T) specimens in [3] suggest that the initial part of the FCG behavior with a smaller slope, which can be observed in the bi-linear trend, may be associated with the compressive residual stress effects whereas the latter part of the bi-linear trend, which shows a higher slope, may be related to tensile residual stress profiles remained in the C(T) weld specimens. In order to interpret the fatigue crack growth results performed on specimens extracted from the welded plates employed in offshore monopiles, and also to provide reliable remaining lifetime estimates of the welded structures operating in offshore environments, neutron diffraction residual stress measurements need to be performed on thick welded plates employed in fabrication of offshore monopiles (e.g. Fig. 1). These measurements need to be performed along the HAZ path (through thickness direction) to examine the significance of residual stress effects in the bi-linear fatigue crack growth behavior of C(T) specimens with the crack path located in the HAZ region.

## CONCLUSIONS

**W**elding residual stress profiles have been found severely sensitive to the yield strength of the filler metal, heat input, plate thickness, fusion zone shape and welding sequence. Numerical studies of multi-pass butt welding in double V-groove thick plates have shown that the highest and the lowest tensile peak stresses are expected to appear when multi-pass welding is performed unevenly and evenly, respectively. The finite element prediction results have shown that the welding sequence influences the residual stress trends and peak values and the changes in residual stresses may be more pronounced in transverse (along X axis) direction compared to the through thickness (along Y axis) direction. However, higher values of damaging residual stresses are generally observed in the through thickness residual stress direction. Suitable welding sequences which result in lower peak values of tensile residual stresses in thick welded plates need to be employed in manufacturing of offshore wind monopiles. Residual stress profiles in offshore structures need to be measured to provide accurate interpretation of the crack growth behavior in offshore welded components. This information also helps to optimize the inspection time required to investigate damage/crack initiation and propagation in offshore wind turbine structures.

## REFERENCES

- [1] Jata, K. V., Sankaran, K. K., and Ruschau, J. J., Friction-stir welding effects on microstructure and fatigue of aluminum alloy 7050-T7451, *Metallurgical and Materials Transactions A.*, 31 (2000) 2181-2192.
- [2] Akita, M., Nakajima, M., Tokaji, K., and Shimizu, T., Fatigue crack propagation of 444 stainless steel welded joints in air and in 3%NaCl aqueous solution, *Materials & Design.*, 27 (2006) 92-99.
- [3] Adedipe, O., Brennan, F., and Kolios, A., Corrosion fatigue crack growth in offshore wind monopile steel HAZ material, in: C.G. Soares, R.A. Shenoi (Eds), *Analysis and Design of Marine Structures V*, CRC Press., (2015) 207-212.
- [4] Jang, C., Cho, P.-Y., Kim, M., Oh, S.-J., and Yang, J.-S., Effects of microstructure and residual stress on fatigue crack growth of stainless steel narrow gap welds, *Materials & Design.*, 31 (2010) 1862-1870.



- [5] James, M. N., Webster, P. J., Hughes, D. J., Chen, Z., Ratel, N., Ting, S. P., Bruno, G., and Steuwer, A., Correlating weld process conditions, residual strain and stress, microstructure and mechanical properties for high strength steel—the role of neutron diffraction strain scanning, *Materials Science and Engineering: A*, 427 (2006) 16-26.
- [6] Deng, D., Murakawa, H., Liang, W., Numerical and experimental investigations on welding residual stress in multi-pass butt-welded austenitic stainless steel pipe, *Computational Materials Science*, 42 (2008) 234-244.
- [7] Chang, P.-H., and Teng, T.-L., Numerical and experimental investigations on the residual stresses of the butt-welded joints, *Computational Materials Science*, 29 (2004) 511-522.
- [8] Murugan, S., Rai, S. K., Kumar, P. V., Jayakumar, T., Raj, B., and Bose, M. S. C., Temperature distribution and residual stresses due to multipass welding in type 304 stainless steel and low carbon steel weld pads, *International Journal of Pressure Vessels and Piping*, 78 (2001) 307-317.
- [9] Liu, C., Zhang, J. X., and Xue, C. B., Numerical investigation on residual stress distribution and evolution during multipass narrow gap welding of thick-walled stainless steel pipes, *Fusion Engineering and Design*, 86 (2011) 288-295.
- [10] Cho, J. R., Lee, B. Y., Moon, Y. H., and Van Tyne, C. J., Investigation of residual stress and post weld heat treatment of multi-pass welds by finite element method and experiments, *Journal of Materials Processing Technology*, 155–156 (2004) 1690-1695.
- [11] Teng, T.-L., Chang, P.-H., and Tseng, W.-C., Effect of welding sequences on residual stresses, *Computers & Structures*, 81(2003) 273-286.
- [12] Ji, S. D., Fang, H. Y., Liu, X. S., and Meng, Q. G., Influence of a welding sequence on the welding residual stress of a thick plate, *Modelling and Simulation in Materials Science and Engineering*, 13 (2005) 553-565.