



## FFS Master Software for Fitness-For-Service assessment of hydrogen induced cracking equipment based on API 579-1/ASME FFS-1

Razieh Karimihaghighi, Masoumeh Naghizadeh  
*University of Western Ontario, Canada*  
rk.arimih@uwo.ca, <https://orcid.org/0000-0002-3085-4192>  
mnaghiza@uwo.ca, <https://orcid.org/0000-0001-5940-4008>

Sirus Javadpour  
*Shiraz University, Iran*  
javadpor@shirazu.ac.ir, <https://orcid.org/0000-0003-3846-5682>

**ABSTRACT.** Over time, industrial equipment, particularly in the oil, gas, and petrochemical industries, is subjected to various forms of degradation and damage that can affect its structural integrity. Most of the Codes and Standards pertaining to components do not address the issues of degradation and damage. As such, performing a Fitness For Service (FFS) assessment is recommended to make run-repair-replace decisions of an in-service component that may be flawed or damaged. In this study, FFS Master – Fitness For Service (FFS) evaluation software –was developed according to the 3rd Edition of the API579-1/ASME FFS-1. The software coding was written using C# programming language equipped with SQL server database. This software is developed specifically for low strength ferritic steel pressurized components with hydrogen induced cracking (HIC), giving the user the ability to accurately assess if system components can continue to operate in their current service condition.

**KEYWORDS.** Hydrogen Induced Cracking; Hydrogen Damage; API 579-1/ASME FFS-1; Fitness For Services (FFS).



**Citation:** Karimihaghighi, R., Naghizadeh, M. Javadpour, S., FFS Master Software For Fitness-For-Service Assessment of Hydrogen Induced Cracking Equipment Based on API 579-1/ASME FFS-1, *Frattura ed Integrità Strutturale*, 60 (2022) 187-212.

**Received:** 09.11.2021  
**Accepted:** 16.01.2022  
**Online first:** 06.02.2022  
**Published:** 01.04.2022

**Copyright:** © 2022 This is an open access article under the terms of the CC-BY 4.0, which permits unrestricted use, distribution, and reproduction in any medium, provided the original author and source are credited.



## INTRODUCTION

**H**ydrogen degradation of ferrous alloys is an important issue in the oil and gas industry for over 100 years [1]. Hydrogen degradation such as hydrogen induced cracking (HIC) occurs most often in pipelines exposed to sour and acidic environments. The hydrogen atoms present at the surface absorb into the structure of the steel and affecting its core strength and ductility properties. It can also lead to formation of cracking and/or blistering of the steel [2–4].

Hydrogen induced cracking (HIC), also known as step-wise cracking, is characterized by laminar cracking accompanied by a through-thickness crack connection. This type of damage typically occurs in carbon steel plates operating in aqueous environment containing hydrogen sulfide, cyanides, hydrofluoric acid, or other species – all of which charge atomic hydrogen into the steel [5].

During HIC phenomenon, hydrogen atoms generated in manufacturing process and/or in reduction reaction during metal corrosion, diffuse into the steel through the interstitial sites. Diffusion of hydrogen into the steel is common, particularly in high concentration of hydrogen atoms. Because the hydrogen atoms are small size compared to the steel lattice structure, and they can easily diffuse into the steel structure. The diffused hydrogen may be trapped at different microstructural features, such as inclusions, defects and large precipitates [6]. Hydrogen permeation, therefore, is dependent on the trapping tendency of steel microstructures, and the concentration and segregation of hydrogen atoms [7]. The trapped hydrogen atoms in these locations can combine to form high pressure hydrogen molecules (gas). As corrosion on the metal surface progresses, more hydrogen atoms are produced on the surface, diffuse into the steel and the pressure inside the steel increases. This often begins the formation of blisters and nucleation of microcracks which then propagate along the precipitates/matrix interface, grain boundaries, and hard phases. Left undetected, this eventually leads to catastrophic failures, even at stresses well below the yield stress [2,4,8].

Despite the fact that corrosion and metal degradation is an inevitable phenomenon, most of the Codes and Standards applying to the equipment do not address these issues. These Standards do not provide information on acceptance criteria on the degradation damages, integrity and remaining product life.

Among all existing Standards, API 579-1/ASME FFS-1 is the best Standard to judge based on the types of damages and flaws presented on the in-service component. This Standard is based on well-known evaluation criteria, recognized as Fitness-For-Service (FFS) assessment. FFS is recognized jointly by the American Petroleum Institute (API) and the American Society of Mechanical Engineers (ASME).

For the HIC evaluation, Part 7 of the Standard allows assessment of hydrogen charging and damage from the process environment. If other types of flaws are presented in the component, they ought to be evaluated utilizing other parts of the Standard.

To facilitate use of API 579-1/ASME FFS-1 standard, several FFS software have been developed to evaluate damage zones in operating components. To obtain that, the procedures provided in each part of the standard is used to code in a proper language programming and make it available for the industries. Compared to the existing software, FFS MASTER is a software which specifically focuses on hydrogen damage according to latest version of Part 7 in API 579-1/ASME FFS-1 standard. So, it's a user-friendly updated software to use for evaluating HIC damaged components in the industries. Moreover this software is equipped with SQL server database which is capable of storing all the entered data and the final report of the evaluated project for documentation and future use.

In this paper, Part 7 of API 579-1/ASME FFS-1 Standard, the FFS MASTER software design and process are described.

## API 579-1/ASME FFS-1 STANDARD

**T**he API 579-1/ASME FFS-1 Standard provides detailed assessment and analysis to determine the structural integrity of an in-service component to identify possible flaws or damage. Such analysis offers a complete evaluation so that decision makers can make accurate determinations on whether to maintain operation or repair equipment or replace it altogether.

The evaluation procedure is arranged in eight steps:

- 1) Determination of the type of damage,
- 2) Applicability and limitations of the procedure,
- 3) Data requirements,
- 4) Assessment techniques and acceptance criteria,
- 5) Remaining life assessment,



- 6) Remediation,
- 7) In-service monitoring,
- 8) Documentation.

For this paper – and the developed software – we focused on Data requirements, Applicability and limitations of the procedure, Assessment techniques and acceptance criteria, along with Documentation.

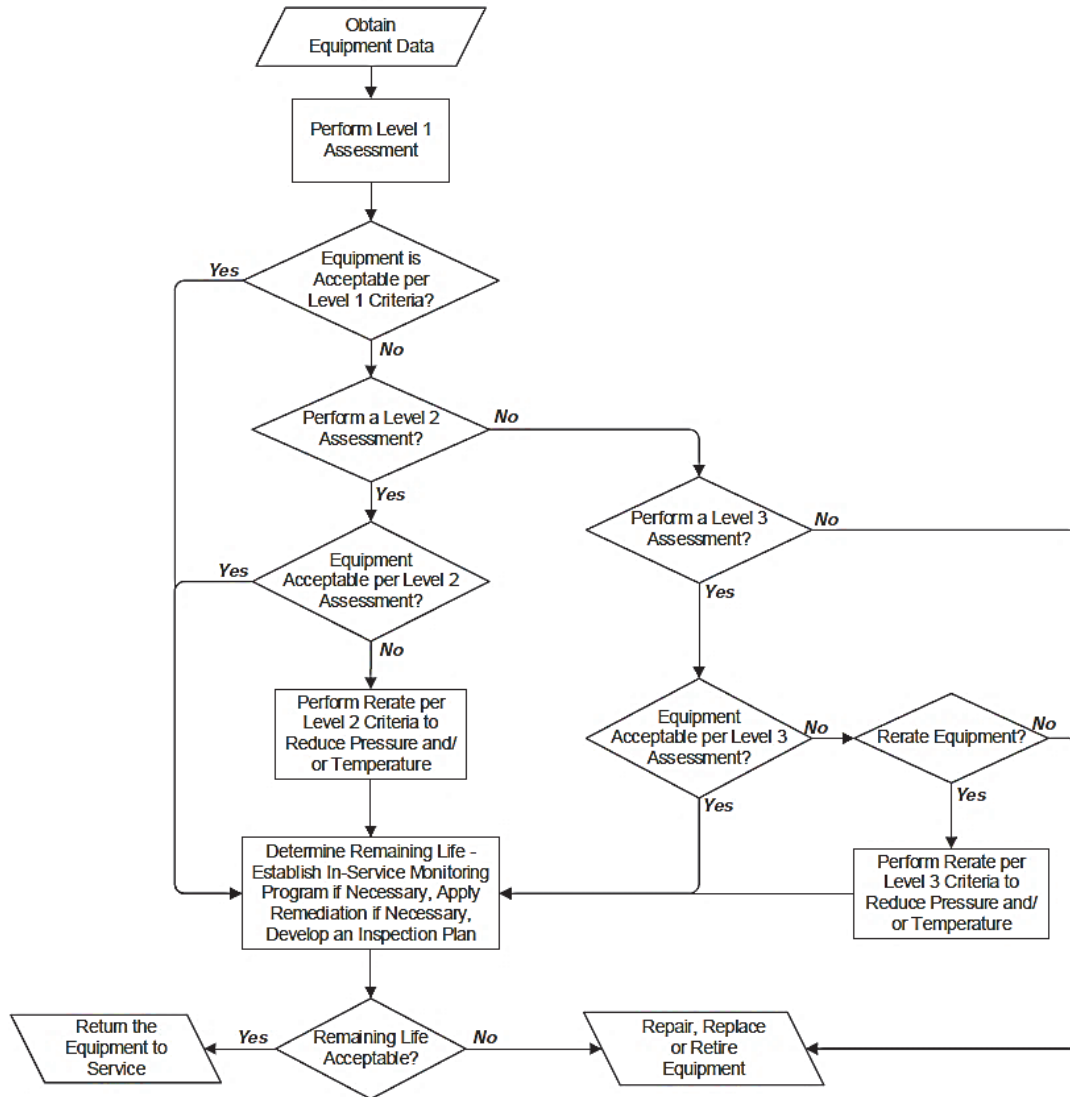

Figure 1: An overview of the FFS assessment procedure according to Part 7 of API 579-1/ASME FFS-1 Standard to evaluate component with Hydrogen Induced Cracking damage [5].

Assessment techniques and acceptance criteria delivers three levels of integrity assessment, from level 1 (basic) to level 3 (sophisticated). An overview of the integrity assessment procedure is illustrated in Figure 1. The condition of the damaged component is determined by considering the prospective of the metal degradation under the service condition [9,10]. The assessment provided in Part 7 considers carbon steel or low alloy steels components with operating temperature less than 204 °C (400 °F); or those below the applicable design curve in API RP 941 Steels for Hydrogen Service at Elevated Temperatures and Pressures in Petroleum Refineries and Petrochemical Plants. Damaged components operating at higher temperature are not considered in this assessment. A brief summary of the each level of assessment and their applicability and limitations are provided below:

Level 1 Assessment provides a conservative acceptance criterion which requires the minimum inspection data. This level is applicable for type A components subject to internal pressure (pressure vessel cylindrical and conical shell sections, spherical pressure vessels and storage spheres, spherical, elliptical and torispherical formed heads, cylindrical atmospheric

storage tank shell courses, straight sections of piping systems and elbows or pipe bends that do not have structural attachments).

A Level 2 Assessment is utilized if Level 1 does not provide satisfactory findings. This level combines less conservative criteria with more detailed results. The required data in this level is similar to Level 1, but higher level calculations and evaluation is performed. This level of assessment is applicable for Type A components subject to internal pressure and supplemental loads and Type B Class 1 components (pressure vessel cylindrical and conical shell sections that are not classified as Type A, and piping systems that not classified as Type A components)

For both Level 1 and 2 assessments, the material must have sufficient toughness. If the toughness of the material is unclear, a brittle fracture analysis (Part 3 of Standard) should be performed.

A Level 3 Assessment is considered when the Level 1 and Level 2 Assessment results are not satisfactory, and/or when the HIC or laminations are close to each other and/or a weld seam or a major structural discontinuity. Compared to two previous levels, Level 3 provided the least conservative and the most detailed method of evaluation. The analysis in this level is based on experimental and inspectional techniques. Level 3 Assessment is performed primarily by engineering specialists who are knowledgeable in performing FFS assessment.

## METHODOLOGY

In this section, the required data for the assessment and the brief explanation of the main calculations of each level of the assessment are described and illustrated.

### Required Data/Measurements for FFS Assessments

The required data measurements for the Level 1 and 2 assessments for HIC damage is listed below and some of them are illustrated in Figure 2. Engineers(s) are required to measure the necessary data to perform the assessment. A list of required data is described below [5]:

HIC spacing to the nearest HIC and/ or blister damage from edge-to-edge, circumferential and longitudinal extent ( $L_{Hl}$ ,  $L_{Hc}$ , and  $L_{Hs}$ ), HIC spacing to weld joints ( $L_W$ ), HIC spacing to major structural discontinuities ( $L_{msd}$ ), HIC through-thickness extent of damage ( $w_H$ ), minimum remaining wall thickness of undamaged metal ( $t_{mm}$ ), from the internal side ( $t_{mm-ID}$ ), from the external side ( $t_{mm-OD}$ ), uniform thickness away from the local metal loss location ( $t_{rd}$ ), HIC damage dimensions from longitudinal and circumferential extent of the damaged zone (s and c), amount of uniform metal loss at the time of inspection ( $LOSS$ ), the inside diameter (D), and future corrosion allowance ( $FCA$ ).

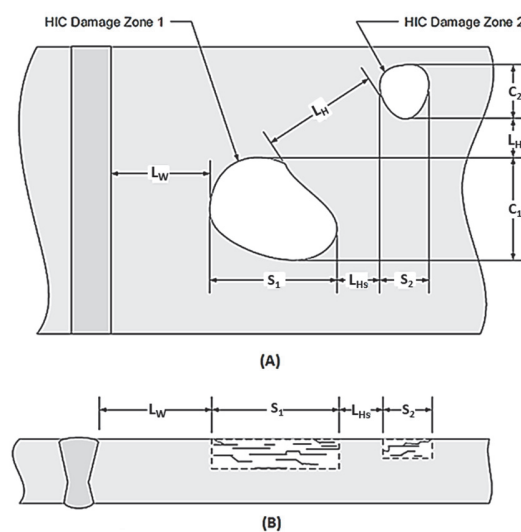

Figure 2: Required measurement for evaluation of HIC, situated close to other HIC and a weld zone: (A) Planar View, (B) Cross Sectional View [5].



*Calculations and Mathematical Analysis Procedures for FFS Assessments*

The FFS evaluation is comprised of specific steps that assess the input data for each type and level of assessment. A brief description of the steps is explained in this section and some extra calculations are provided in the Appendixes A and B.

**Level 1 Assessment for HIC:** The steps for Level 1 of HIC assessment are listed below. This assessment is the least complicated. If all the criteria are acceptable, then the component can be returned to service [5].

The first step is determining the corroded wall thickness. This can be determined by Equation 1a or 1b:

$$t_c = t_{nom} - LOSS - FCA \tag{1a}$$

or

$$t_c = t_{nd} - FCA \tag{1b}$$

where  $t_c$  is the corroded wall thickness,  $t_{nom}$  is nominal thickness of the component adjusted for mill under tolerance as applicable,  $t_{nd}$  is uniform thickness away from the local metal loss location,  $FCA$  is future corrosion allowance.

The second step is to evaluate all the required measurement data (defined in previous section) and the corroded wall thickness (from **Step 1**). If any of the requirements are not acceptable, then Level 1 Assessment is not satisfactory.

a)  $s$  and/or  $c \leq \sqrt{Dt_c}$  (2)

b)  $w_H \leq \min \left[ \frac{t_c}{3}, 13 \text{ mm} (0.5 \text{ in}) \right]$  (3)

c)  $L_w > \max [2t_c, 25 \text{ mm} (1.0 \text{ in})]$  (4)

d)  $L_{msd} \geq 1.8 \sqrt{Dt_c}$  (5)

e) The HIC damage is not surface breaking

f) HIC damage is prevented by (a) a barrier coating or overlay and/or (b) the equipment would operate in an environment with no further hydrogen charging of the metal.

If the component does not meet the Level 1 Assessment requirements, the damaged material may be removed, repaired or replaced and/or a Level 2 assessment can be performed.

**Level 2 Assessment for HIC:** The first two steps in Level 2 are similar to those conducted in the Level 1 assessment. In Level 2, Equation 4 and 5 need be satisfied (**Step 1, 2**), otherwise this level is not acceptable in general. If the Equation 4 and 5 are acceptable, then the Maximum Allowable Working Pressure (*MAWP*) (see Appendix A) for a pressurized components and Maximum Fill Height (*MFH*) for an atmospheric storage tank is determined (**Step 3**). Otherwise, Level 2 Assessment is not satisfied.

In **Step 4**, the remaining strength factor (RSF) concept is used to determine the acceptability of a component for continued service. RSF is determined based on a general equation (Equation 6):

$$RSF = \frac{L_{DC}}{L_{UC}} \tag{6}$$

where  $L_{DC}$  represents the limit or plastic collapse load of the damaged component and  $L_{UC}$  is the limit or plastic collapse load of the undamaged component. Note however, the specific RSF for surface-breaking HIC damage and the sub-surfaced HIC damage are determined by a more detailed equation, based in Equation 7a and 8a. The Remaining Strength Factor (RSF) for 1) surface-breaking HIC damage is determined using Equation 7a:



$$RSF = \frac{1 - \left[ \frac{w_H \cdot D_H}{t_c} \right]}{1 - \frac{1}{M_t} \left[ \frac{w_H \cdot D_H}{t_c} \right]} \tag{7a}$$

$$\lambda = \frac{1.285s}{\sqrt{Dt_c}} \tag{7b}$$

where  $D_H$  is the damage parameter and for the HIC damage it is set as 0.80.  $M_t$  is Folias Factor and determined from Table 1 by using the value of  $\lambda$  (Longitudinal or Meridional Flaw Parameter).

$\lambda$	$M_t$	
	Cylindrical or Conical Shell	Spherical Shell
0	1.002	1.000
0.5	1.056	1.063
1	1.199	1.218
1.5	1.394	1.427
2	1.618	1.673
2.5	1.857	1.946
3	2.103	2.240
3.5	2.351	2.552
4	2.600	2.880
4.5	2.847	3.221
5	3.091	3.576
5.5	3.331	3.944
6	3.568	4.323
6.5	3.801	4.715
7	4.032	5.119
7.5	4.262	5.535
8	4.492	5.964
8.5	4.727	6.405
9	4.970	6.858
9.5	5.225	7.325
10	5.497	7.806
10.5	5.791	8.301
11	6.112	8.810
11.5	6.468	9.334
12	6.864	9.873
12.5	7.307	10.429
13	7.804	11.002
13.5	8.362	11.592
14	8.989	12.200
14.5	9.693	12.827
15	10.481	13.474
15.5	11.361	14.142
16	12.340	14.832
16.5	13.423	15.544

Table 1: Determining Folias Factor ( $M_t$ ) for Cylindrical, Conical and Spherical Shells, Based on  $\lambda$  (the Longitudinal or Meridional Flaw Parameter) [5].



2) Subsurface HIC damage is determined in Equation 8a.

$$RSF = \frac{2L_R + s \left[ 1 - \left( \frac{w_H \cdot D_H}{t_c} \right) \right]}{2L_R + s} \quad (8a)$$

$$L_R = \min \left[ \frac{L_{Hs}}{2}, 8t_c \right] \quad (8b)$$

If the calculated  $RSF \geq RSF_a$  ( $RSF_a$  – allowable remaining strength factor, mainly considered 0.9) the HIC damage satisfies the MAWP or MFH (**Step 5**). If the  $RSF < RSF_a$  the MAWP or MFH are not satisfactory, calculation methods are provided to modify the component service condition. These calculation methods can be used to discover Reduced Maximum Allowable Working Pressure ( $MAWP_r$ ) for pressurized equipment. The calculation methods are also used to determine Reduced Maximum Fill Height ( $MFH_r$ ) [1]. The equations are as follows:

$$MAWP_r = MAWP \left( \frac{RSF}{RSF_a} \right) \quad (9a)$$

$$MFH_r = H_f + (MFH - H_f) \left( \frac{RSF}{RSF_a} \right) \quad (9b)$$

where  $H_f$  is the distance between the bottom of the flaw and the tank bottom.

In **Step 6**, it is necessary to determine whether a fracture assessment is required or not. If any of options below apply to the system, then proceed to Step 7. Otherwise, proceed to Step 8.

- 1) The equipment remains operating in hydrogen charging environment and hydrogen charging is not prohibited on metals surface by a barrier coating, overlay, or process change.
- 2) The HIC damage is of a surface-breaking type.
- 3) The HIC damage through-wall satisfies:

$$w_H > \min \left[ \frac{t_c}{3}, 13 \text{ mm} (0.5 \text{ in}) \right] \quad (10)$$

In **Step 7**, HIC damage is evaluated as a crack-like flaw in accordance to Part 9 of the Standard. A brief overview of the crack-like flaw FFS assessment is provided in Figure 3. An assessment description is provided in the Appendix B.

**Step 8** determines if further HIC damage is prevalent or is limited to a certain rate, using any of the following methods:

- Barrier coating, inhibitors, and modification of the process
- Monitoring hydrogen diffusion through the equipment
- Monitoring HIC damage size and defects to ensure growth rates are within expected limits. Otherwise, this level is not satisfied.

**Step 9** reviews the steps to determine if steps in Level 2 are satisfied, and helping decide if the component can be returned to service. If it cannot, the component may be removed, repaired, or replaced.

Level 3 Assessment for HIC: Level 3 Assessment is conducted if Level 2 assessment is not satisfied due to complex component geometry, applied loading or the existing damage is close to structural discontinuities. This level of assessment features detailed inspection and evaluation techniques utilizing the stress analysis methods of damaged equipment. Since Level 3 is mainly a maintenance technique conducted by engineers or FFS experts, the FFS MASTER software omits this level.



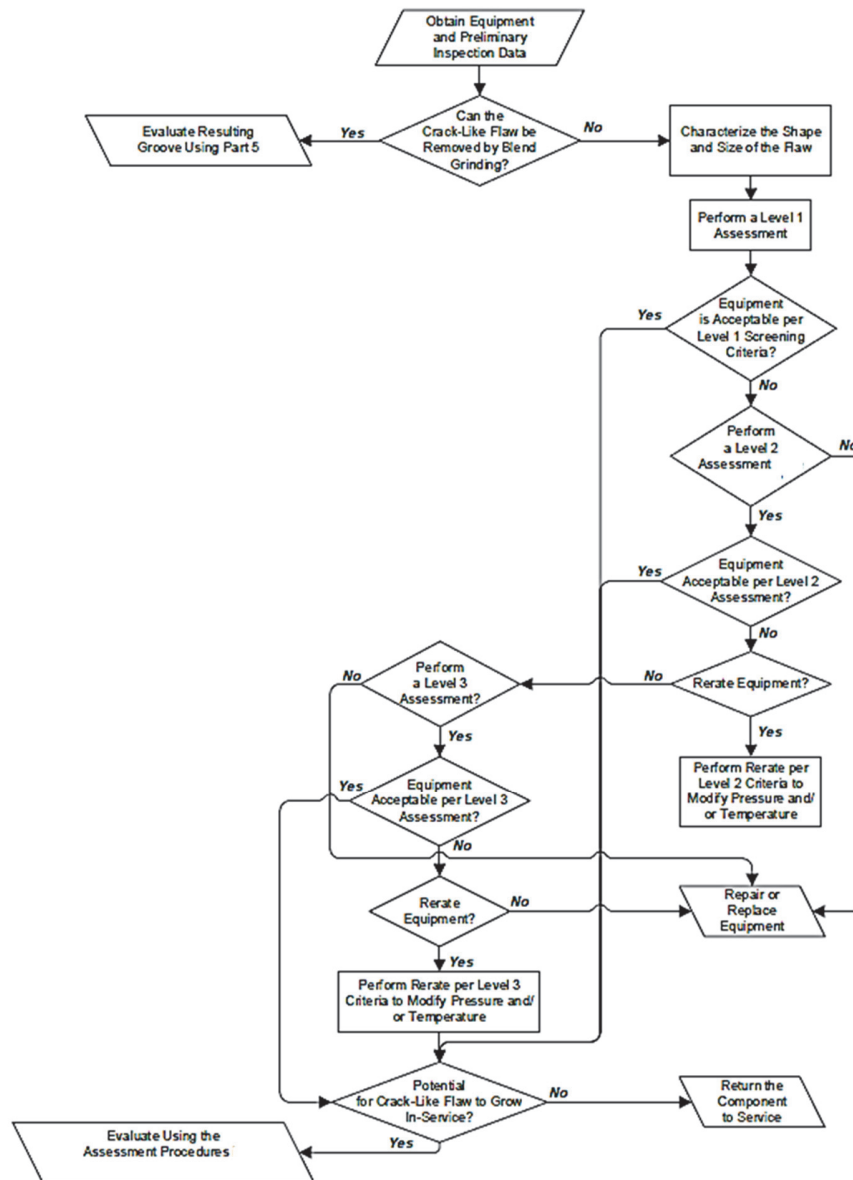

Figure 3: Overview of an FFS analysis for crack-Like Flaws based on Part 9 of API 579-1/ASME FFS-1 Standard [5].

## SOFTWARE DESIGN AND DISCUSSION

**F**FS MASTER is software developed according to Level 1 and Level 2 assessments of HIC evaluation in Part 7 of API 579-1/ASME FFS-1(2016). The software facilitates performing FFS assessment in any industry, particularly in oil and gas refining industry, petrochemical industry, power plants, and chemical production plants where HIC damage occurs recurrently in operating equipment.

This software performs the necessary calculations and examines conditions to determine the validity of continuing operation of equipment with HIC damage in operational units. The calculations include determining  $RSF$ ,  $MAWP$ ,  $MAWP_r$ , crack-like flaw assessment (Part 9) and other calculations mentioned in methodology section.

There are 4 main features in the software:

- 1) Equipped with SQL server database to store input data. This also enables the user to retrieve past data and edit it, as necessary.
- 2) Enables user to run both Level 1 and 2 assessments to evaluate damaged equipment.





- 3) Program windows contain tool bars (Figure 4) for ease-of-use. Create a new project, save or exit the program, utilize converter, even access the Standard and check evaluation examples.
- 3) A full report with inputted data can be created, including recommendations that aid in the decision-making process.

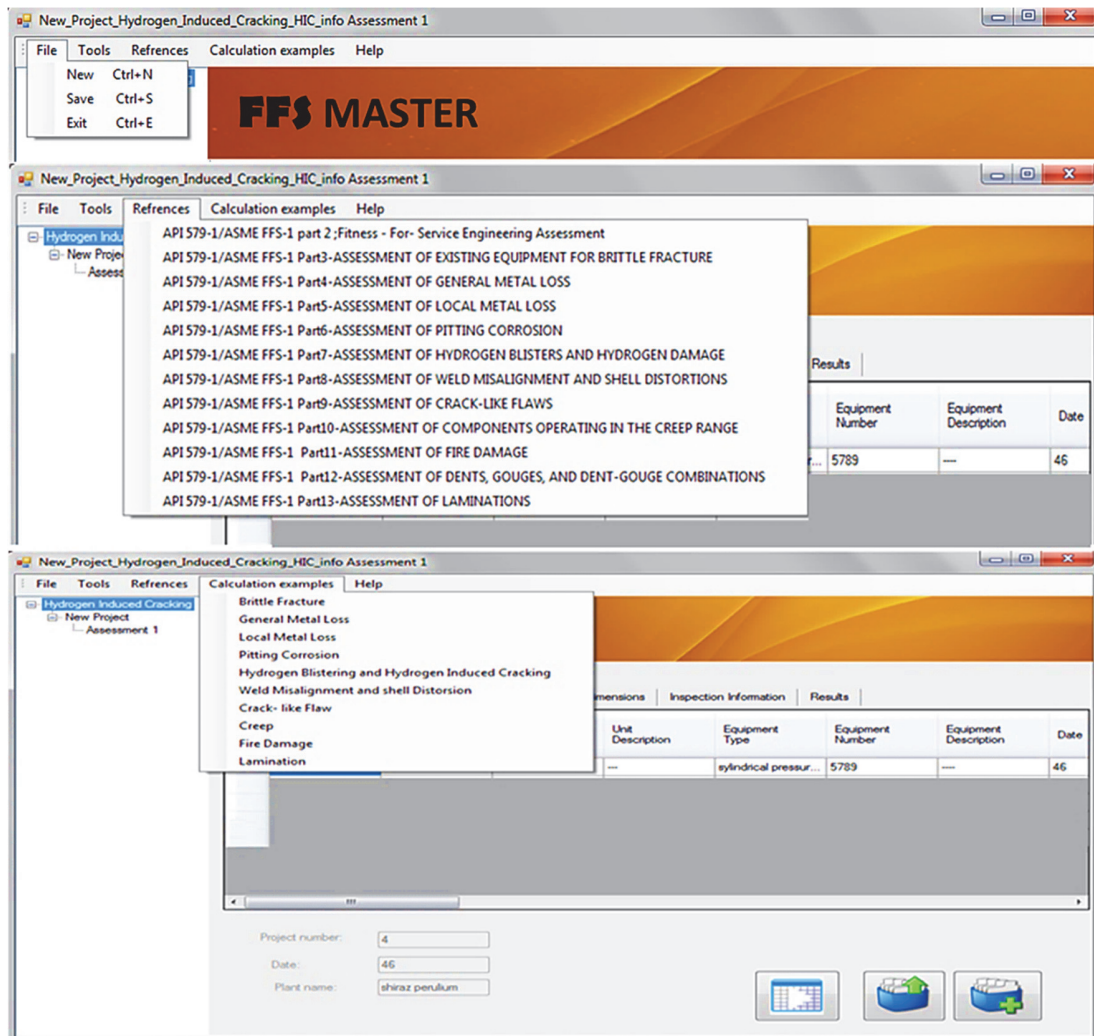

Figure 4: Each software page has a tool bars to facilitate accessing documents, convertor or other actions.

To start the assessment, the user begins by selecting evaluation pathway (Figure 5): 1) The first pathway is the “**New Project**” module, allowing the user to save a project or retrieve a past project and 2) The second pathway is the “**Quick Analysis**” module for a fast evaluation. There’s no need to enter extra data to the database, and by selecting any module the assessment is launched.

**New Project Module:** This module opens the Level 1 Assessment window, with a tab bar (Database, Project Info., Design and Location Info., Demotions, Inspection Info., Report) illustrated in Figure 6. In Level 1 assessment, each tab bar has a specific design, including tool boxes that enable the user to enter required data or generate a report of the final assessment result. The tab bars are described below:

- “**Database**” tab bar illustrates data grid view which is directly connected to SQL server database. Users have access to previous saved project data. Each project has been stored by date, project number, plants name, equipment number and the required entered data and descriptions.
- “**Project Info.**”, “**Design and Location Info.**”, “**Dimension**”, and “**Inspection Info.**” tab bars contain boxes to enter project descriptions, equipment design information, and required dimensions (Figure 6).

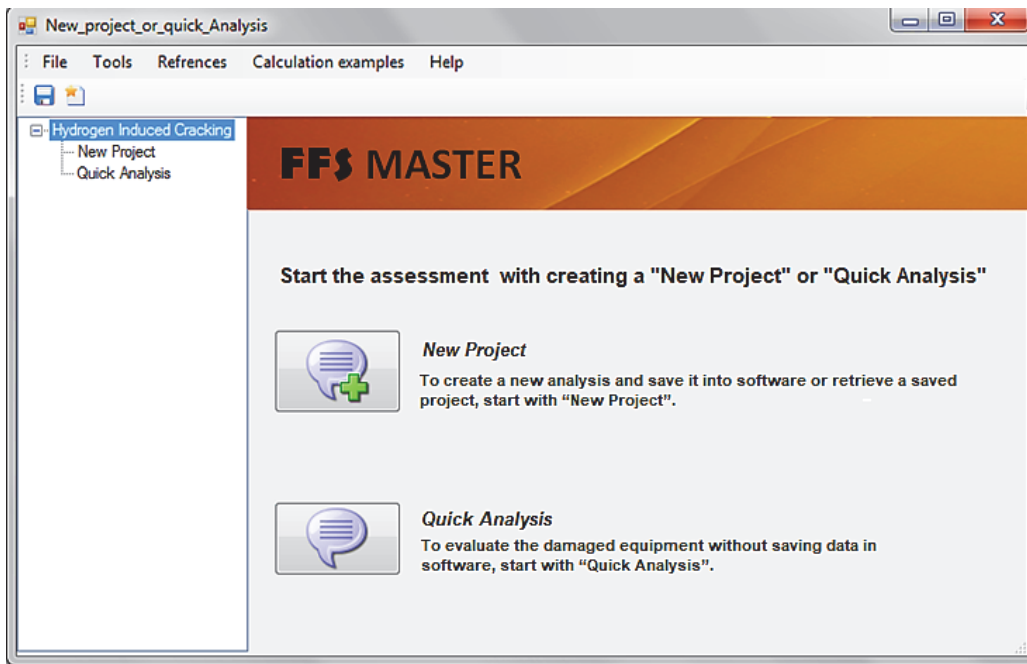

Figure 5: Selecting evaluation pathway in software: 1) New Project, 2) Quick Analysis

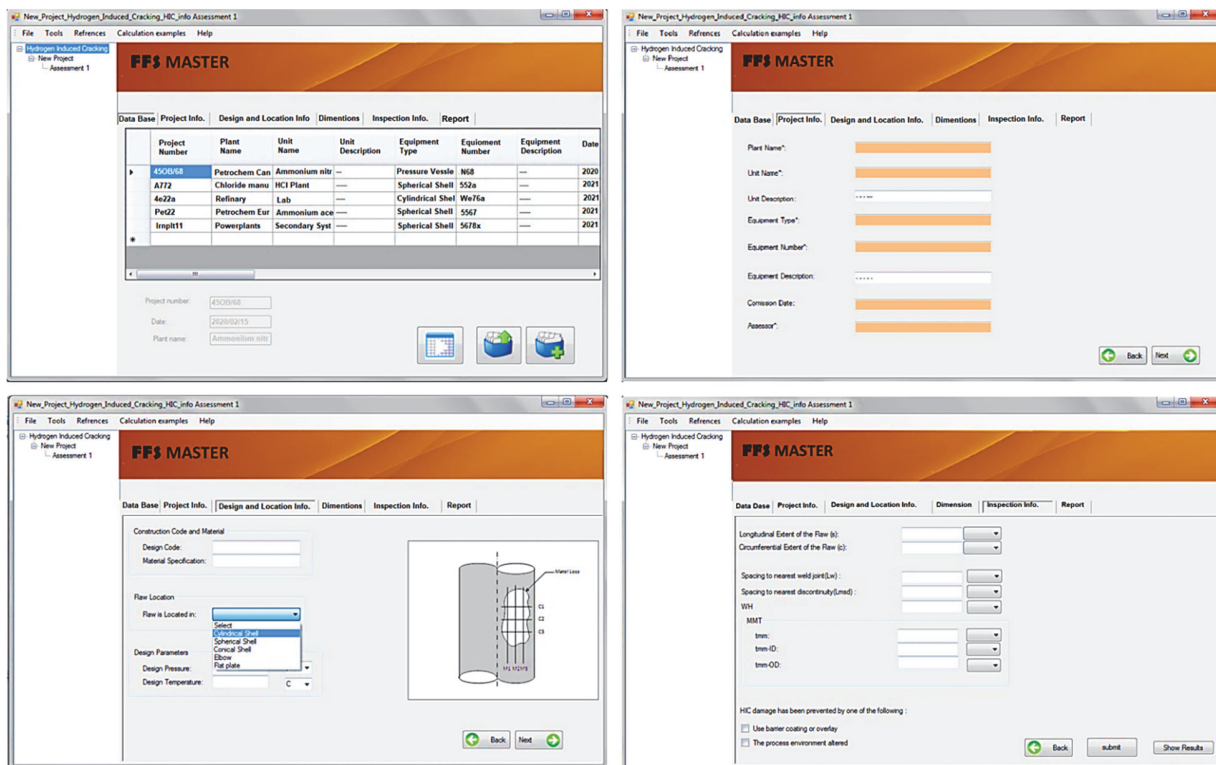

Figure 6: Level 1 Assessment tab bar headings: Database, Project Info., Design and Location Info., Demotions, Inspection Info., Report.

- **“Report”** tab provides a list of input data with units, final results obtained from the FFS assessment calculations, and the suggestions. This report can be printed and/or saved by user. Also it is automatically stored in the SQL server database for future access.



If criteria of Level 1 assessment are not satisfied, starting Level 2 assessment is recommended. The software automatically presents Level 2 Assessment for the user.

Similarly to Level 1 Assessment, Level 2 contains tab bars (Design and Location Info., Dimensions, Inspection Info., Calculation, and Report). In the first two tab bars (Design and Location Info., Dimensions); the inputted data in Level 1 is displayed, but not editable. This helps to double-check the inputted data in Level 1 while doing the Level 2 Assessment.

In Inspection Info and Calculations tabs, user can enter the required data for the Level 2. The Level 2 Assessment includes crack-like flaw assessment (according to Part 9 of the Standard), and the required information for this evaluation is taken in Calculation tab bar (shown in Figure 7). In this tab bar, detailed information on material properties and loading condition are taken from user to determine the state of stress at the location of the flaw. Also Calculation tab bar get the required data to determine the maximum allowance crack-like flaw length based on equipment's material, shape and geometry, and the lowest (coldest) metal temperature operating conditions (CET) (see Appendix B). Crack-like flaw assessment is limited to pressurized cylinders, spheres or flat plates away from all structural discontinuities.

Determining the maximum allowance crack-like flaw length vs temperature is done by assessing curve figures which can be performed manually or automatically in the software. This can be easily accomplished by choosing, if user prefer to evaluate figure manually or automatically by software (Figure 7 and 8).

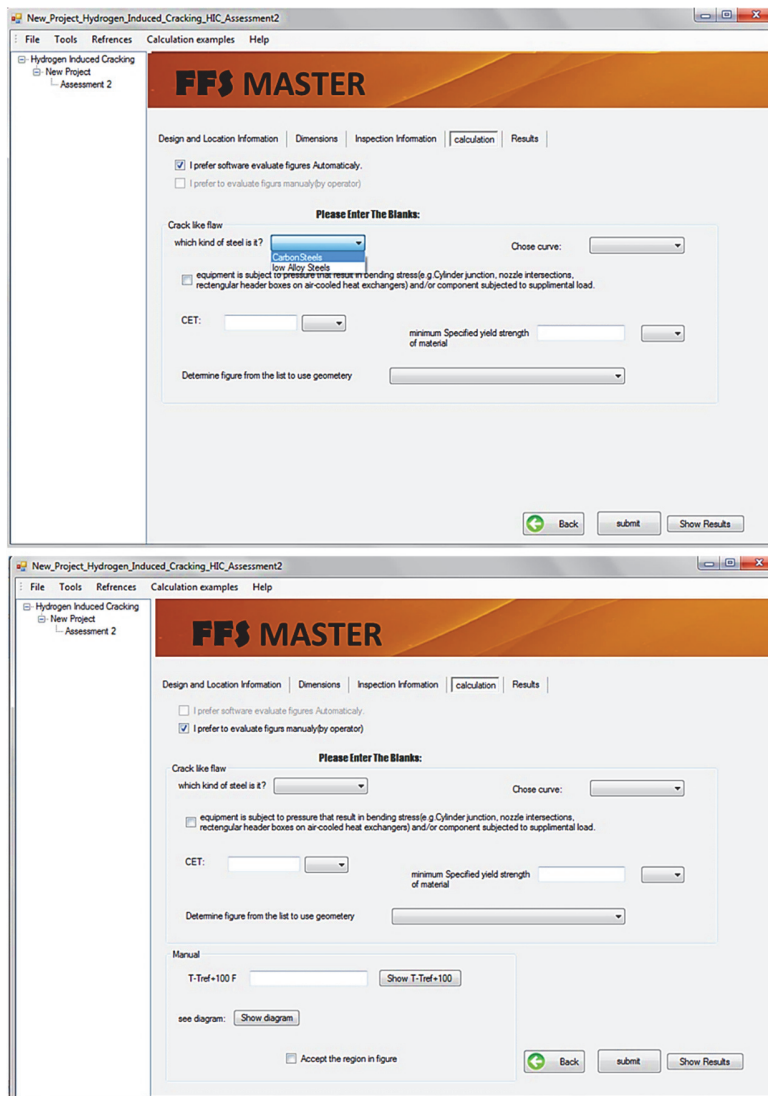

Figure 7: Calculation tab bar, which specifically evaluates HIC damage as a Crack-like flaw. Upper figure evaluate crack size vs temperature automatically and below figure evaluate it manually by operator.

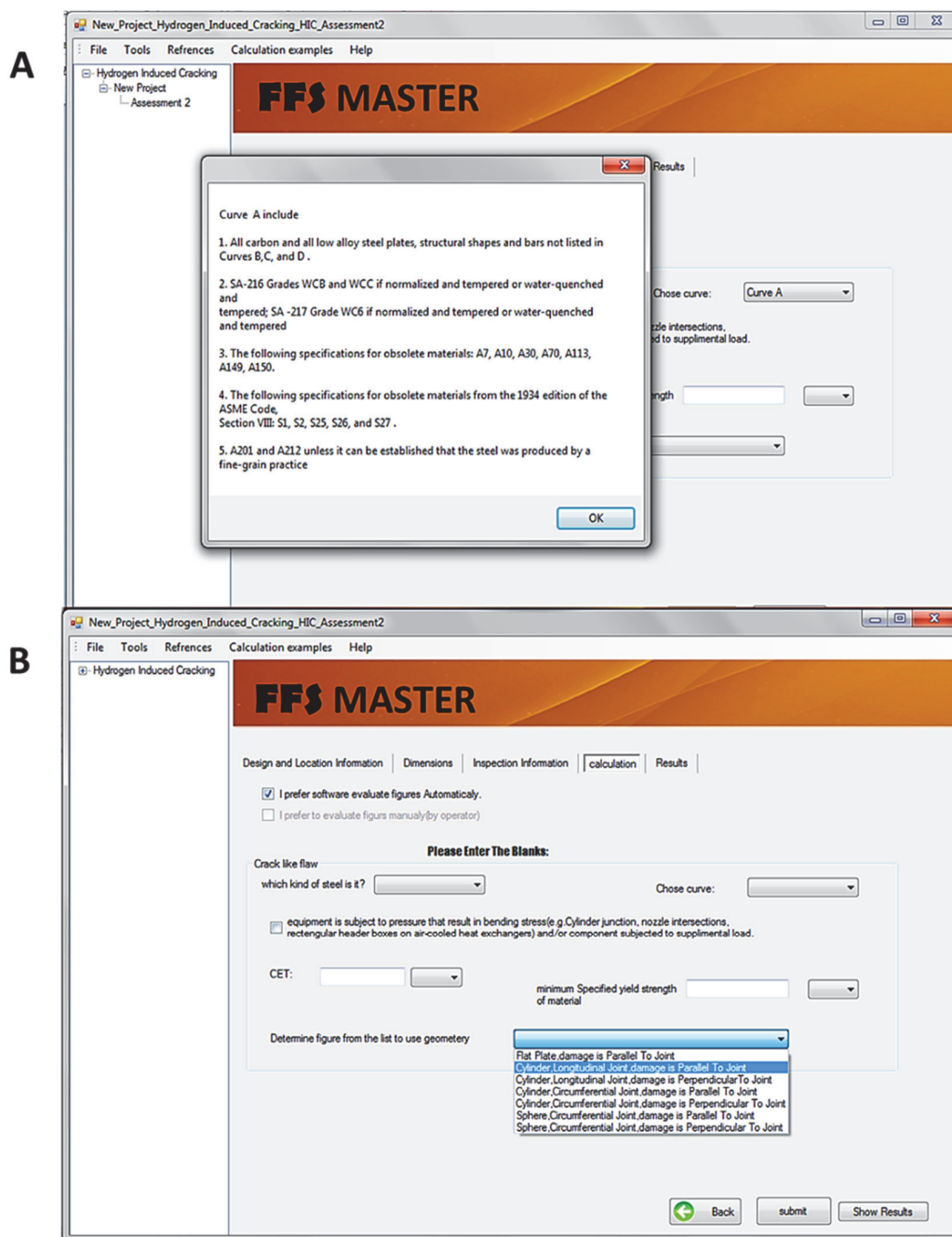

Figure 8: Selecting the curve type based on damaged equipment (A) material and (B) geometry.

For manual figure evaluation, user can decide about the acceptance or rejection of the crack-like flaw assessment based on the assessment figure. However in the automatic evaluation the acceptance and rejection is done automatically by software. For this aim, the mathematical equations correspond to each seven graph are determined by Microsoft Excel (Figure 9) and by using the equations in conditional statement in C# coding, decision making according to graphs is carried out.

The assessment curve figures (crack size vs. temperature) are provided for flat plates, cylinders and spheres operating as base metal, weld metal that has been subject to post weld heat treated (PWHT), and weld metal that has not been subject to PWHT with longitudinal and circumferential joint and crack like flaw parallel or perpendicular to the joint (see Appendix B).



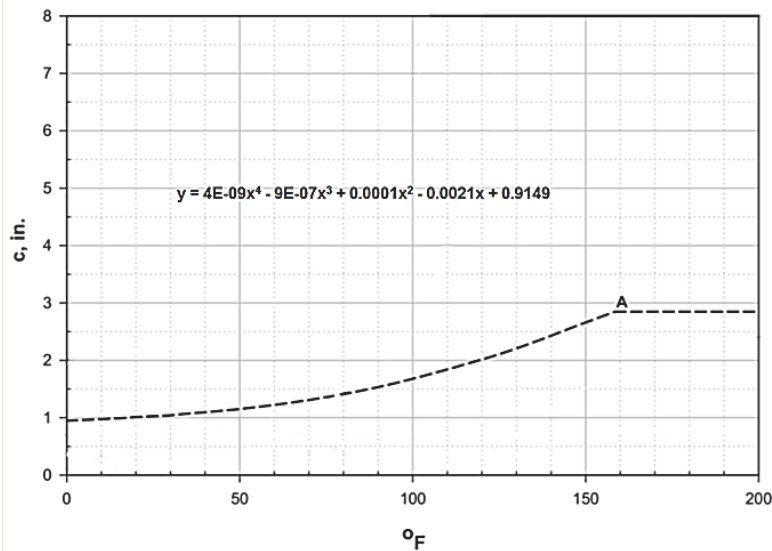

Figure 9: An example of the mathematical equations corresponds to each seven graph is determined by Microsoft Excel (all 7 graphs provided in Appendix B).

After entering all required data in Calculation tab bar, the user can move forward to Report tab bar to obtain the final report from Level 2 Assessment. Similar to the report created in Level 1 Assessment, all the entered data from Level 1 and Level 2 is displayed on this page along with the assessment result and final suggestion.

**Quick Analysis Module:** This Module is similar to the New Project module, albeit in this feature some pages are not present and/or some data need not be entered, such as Database tab bar and Project Info (Figure10). As mentioned earlier, any data entered in this module is not stored in the software database.

Similar to New Project Module, the evaluation starts with Level 1 and required data for the assessment should be entered. If Level 1 assessment is not satisfied, Level 2 assessment can be performed which also consist of crack-like flaw assessment. At the end of each assessment level, a report is provided to aid in final decisions and suggestions.

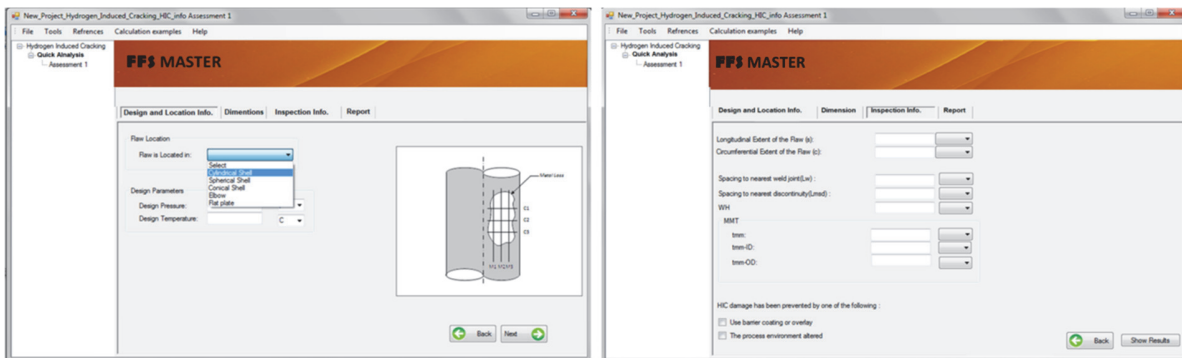

Figure 10: Quick Analysis Module in Level 1 assessment

## CONCLUSION

The FFS Master software for Hydrogen Induced Cracking (HIC) is based on Part 7 of the current (third) edition of the API 579-1/ASME FFS-1 Standard (2016). The software source code was written in C# programming language in Visual Studio, with a SQL server database. Due to the inherently complex procedures and mathematical calculations of the API 579-1/ASME FFS-1 Standard, using this software is a fast and accurate way to evaluate FFS assessment for damaged equipment in industries. The proposed assessment in the Standard –precisely coded in the software – helps inspectors and plant corrosion engineers to prevent catastrophic failure in components with HIC



damage.

The evaluation procedure in the Standard is divided in three main assessment levels, Level 1, 2 and 3. The evaluation begins at Level 1 (most conservative) to Level 3 (most sophisticated). A Level 1 assessment provides conservative acceptance criteria and requires the minimum inspection data. A Level 2 Assessment is conducted if Level 1 is not satisfied. This level uses less conservative criteria to provide more detailed results. In Level 2 Assessment, the HIC damage is considered as crack-line flaw which incorporate Part 9 of the Standard as well. A Level 3 assessment is necessary when neither a Level 1 or Level 2 assessment are satisfied, and/or the HIC damage or laminations are in proximity each other, a weld seam or major structural discontinuity. Level 3 Assessment is used mainly for inspection procedures and not included in the software.

The assessment provided in Part 7 considers carbon steel or low alloy steels components with operating temperature less than 204 °C (400 °F); or those below the applicable design curve in API RP 941 Steels for Hydrogen Service at Elevated Temperatures and Pressures in Petroleum Refineries and Petrochemical Plants. Damaged components operating at higher temperatures are not considered in this assessment.

In this paper, assessment steps of Part 7 of API 579-1/ASME FFS-1, and software programming procedure were described in details, including required data preparation, mathematical calculations, and software design. It is clear that the software is capable to accurately and rapidly perform all necessary assessments.

## REFERENCES

- [1] Park, J.S., Lee, J.W., Kim, S.J. (2021). Hydrogen-Induced Cracking Caused by Galvanic Corrosion of Steel Weld in a Sour Environment, pp. 1–8, DOI: 10.3390/ma14185282.
- [2] Jack, T.A., Pourazizi, T., Ohaeri, E., Szpunar J., Zhang, J., Qu J. (2020). Investigation of the hydrogen induced cracking behaviour of API 5L X65 pipeline steel, *Int. J. Hydrogen Energy*, 45(35), pp. 17671-17684, DOI: 10.1016/j.ijhydene.2020.04.211.
- [3] Norsworthy, R. (2014). Understanding corrosion in underground pipelines: basic principles. *Underground Pipeline Corrosion*, pp. 3–34, DOI: 10.1533/9780857099266.1.3.
- [4] Traidia, A., Alfano, M., Lubineau, G., Duval, S., Sherik, A. (2012). An effective finite element model for the prediction of hydrogen induced cracking in steel pipelines, *Int. J. Hydrogen Energy*, 37(21), pp. 16214–16230, DOI: 10.1016/j.ijhydene.2012.08.046.
- [5] API RP 579-1 / ASME FFS-1 (2016). *Fitness for Service*, American Petroleum Institute, Third Edition.
- [6] Wang, Z., Liu, J., Huang, F., Bi, Y.J., Zhang, S.Q. (2020). Hydrogen Diffusion and Its Effect on Hydrogen Embrittlement in DP Steels With Different Martensite Content, *Front. Mater.*, 7, pp. 1–12, DOI: 10.3389/fmats.2020.620000.
- [7] Mallick, D., Mary, N., Raja, V.S., Normand, B. (2021). Study of diffusible behavior of hydrogen in first generation advanced high strength steels, *Metals (Basel)*, 11(5), DOI: 10.3390/met11050782.
- [8] Ramirez, M.F.G., Hernández, J.W.C., Ladino, D.H., Masoumi, M., Goldenstein, H. (2021). Effects of different cooling rates on the microstructure, crystallographic features, and hydrogen induced cracking of API X80 pipeline steel, *J. Mater. Res. Technol.*, 14, pp. 1848–1861, DOI: 10.1016/j.jmrt.2021.07.060.
- [9] Zangeneh, S., Lashgari, H.R., Sharifi, H.R. (2020). Fitness-for-service assessment and failure analysis of AISI 304 demineralized-water (DM) pipeline weld crack, *Eng. Fail. Anal.*, 107, DOI: 10.1016/j.engfailanal.2019.104210.
- [10] Kasivitanuay, J., Singhatanadgid, P. (2020). Object-oriented software for fitness-for-service assessment of cracked cylinder based on API RP 579, *Frat. Ed Integrita Strutt.*, 14(52), pp. 163–180, DOI: 10.3221/IGF-ESIS.52.14.

## APPENDIX A

### MAWP (Maximum Allowable Working Pressure)

- **Cylindrical Pressure Vessel Shells [5]:**

a) Longitudinal joints with circumferential stress when  $P \leq 0.385SE$  and  $t_{min}^C \leq 0.5R$  .

$$MAWP^C = \frac{SEt}{R + 0.6t} \tag{A1}$$



- b) Longitudinal joints with circumferential stress when  $P > 0.385SE$  and  $t_{min}^C > 0.5R$  :

$$MAWP^C = SE \ln \left[ \frac{R+t}{R} \right] \quad (A2)$$

- c) Circumferential joints with longitudinal stress when  $P \leq 1.25SE$  and  $t_{min}^L < 0.5R$  :

$$MAWP^L = \frac{2SE(t-t_{sl})}{R+0.4(t-t_{sl})} \quad (A3)$$

- d) Longitudinal stress when  $P > 0.385SE$  and  $t_{min}^C > 0.5R$  (circumferential joints):

$$MAWP^L = SE \left( \left( \frac{R+(t-t_{sl})}{R} \right)^2 - 1 \right) \quad (A4)$$

- e) Final Values:

$$MAWP = \min [MAWP^C, MAWP^L] \quad (A5)$$

• **Spherical Pressure Vessel Shells [5]:**

- a)  $P \leq 0.665SE$  and  $t_{min} \leq 0.356R$

$$MAWP = \frac{2SEt}{R+0.2t} \quad (A6)$$

- a)  $P > 0.665SE$  or  $t_{min} > 0.356R$

$$MAWP = 2SE \left( \left( \frac{R+t}{R} \right)^3 - 1 \right) \left( \left( \frac{R+t}{R} \right)^3 + 2 \right)^{-1} \quad (A7)$$

• **Conical Pressure Vessel Shells [5]:**

- a) Longitudinal joints with Circumferential Stress.  $\alpha$  and D are illustrated in Figure A1.

$$MAWP^C = \frac{2SEt \cos[\alpha]}{D+1.2t \cos[\alpha]} \quad (A8)$$

- b) Circumferential joints with longitudinal stress

$$MAWP^L = \frac{2SE(t-t_{sl}) \cos[\alpha]}{D+0.8(t-t_{sl}) \cos[\alpha]} \quad (A9)$$

- c) Final Value

$$MAWP = \min [MAWP^C, MAWP^L] \quad (A10)$$



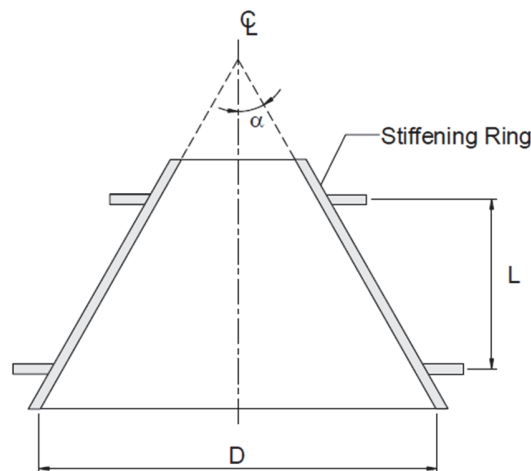

Figure A1: Conical Shell Geometry [5].

## APPENDIX B

Instructions for a crack-like flaw assessment are briefly described below:

a) This assessment is limited to crack-like flaws in pressurized cylinders, spheres or flat plates away from all structural discontinuities.

b) In this assessment detailed information on loading condition and material properties is required to determine the state of stress at the location of the flaw.

The steps in Level 1 assessment is listed below [5]:

**Step 1:** Determine the temperatures, Critical Exposure Temperature (CET (the lowest (coldest) metal temperature conditions)) and the load cases in operating and design conditions.

**Step 2:** Determine the flaw length and depth from inspection data.

**Step 3:** Select the component geometry and crack-like flaw orientation with respect to the weld joint for determining the assessment figure:

- 1) Flat plate, crack-like flaw parallel to the joint (Figure B1).
- 2) Cylinder, longitudinal joint, crack-like flaw parallel to the joint (Figure B2).
- 3) Cylinder, longitudinal joint, crack-like flaw perpendicular to the joint (Figure B3).
- 4) Cylinder, circumferential joint, crack-like flaw parallel to the joint (Figure B4).
- 5) Cylinder, circumferential joint, crack-like flaw perpendicular to the joint (Figure B5).
- 6) Sphere, circumferential joint, crack-like flaw parallel to the joint (Figure B6).
- 7) Sphere, circumferential joint, crack-like flaw perpendicular to the joint (Figure B7).

**Step 4:** For each figure in Step 3, 1/4-t and 1-t crack depths screen curve, are provided for base metal, weld metal that has been subject to Post Weld Heat Treated (PWHT), and weld metal that has not been subject to PWHT.

If the damage is located at the weld, or within a distance of  $2t_{nom}$  of the plate from centerline of the weld, then the curves for weld metal should be used; otherwise, the curve for base metal may be used.

To select the screen curve is criteria are assessed:

i) For  $t \leq 25\text{mm}$  (1 in):

I) if  $w_H \leq t/4$ , then the 1/4-t screening curves shall be used.

II) if  $w_H > t/4$ , then the 1-t screening curves shall be used.

ii) For  $25\text{mm}$  (1 in)  $< t \leq 38\text{mm}$  (1.5 in):

I) if  $w_H \leq 6\text{mm}$  (0.25 in), then the 1/4-t screening curves shall be used.

II) if  $w_H > 6\text{mm}$  (0.25 in), then the 1-t screening curves shall be used.

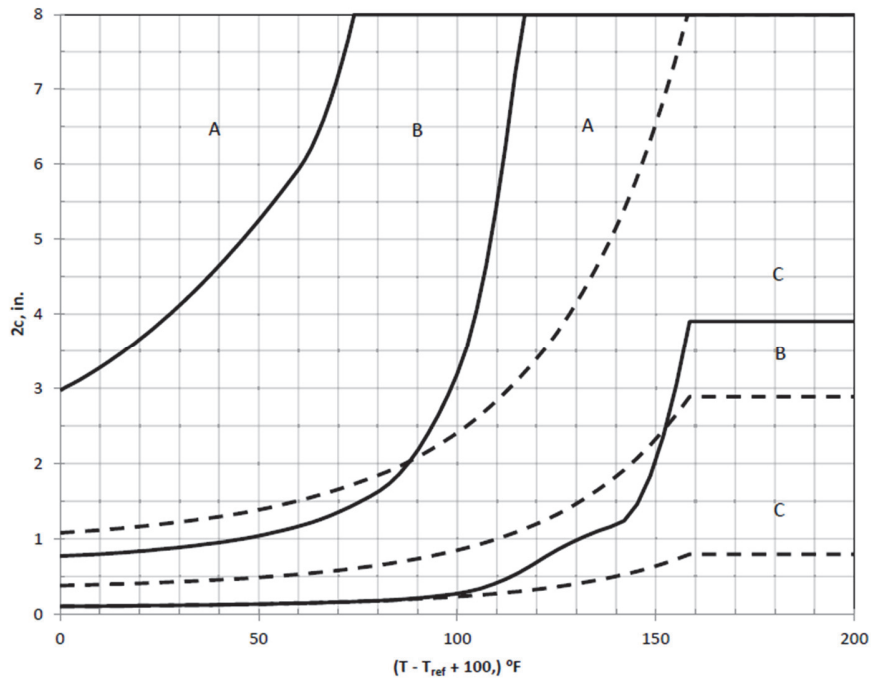

Figure B1: Determine the maximum allowance crack-like flaw length in flat plate, crack-Like flaw parallel to the joint for A) Allowable flaw size in base metal. B) Allowable flaw size in weld metal that has been subject to PWHT. C) Allowable flaw size in weld metal that has not been subject to PWHT- for each material solid line refers to 1/4- flaw, and dashed line refers to 1- flaw [5].

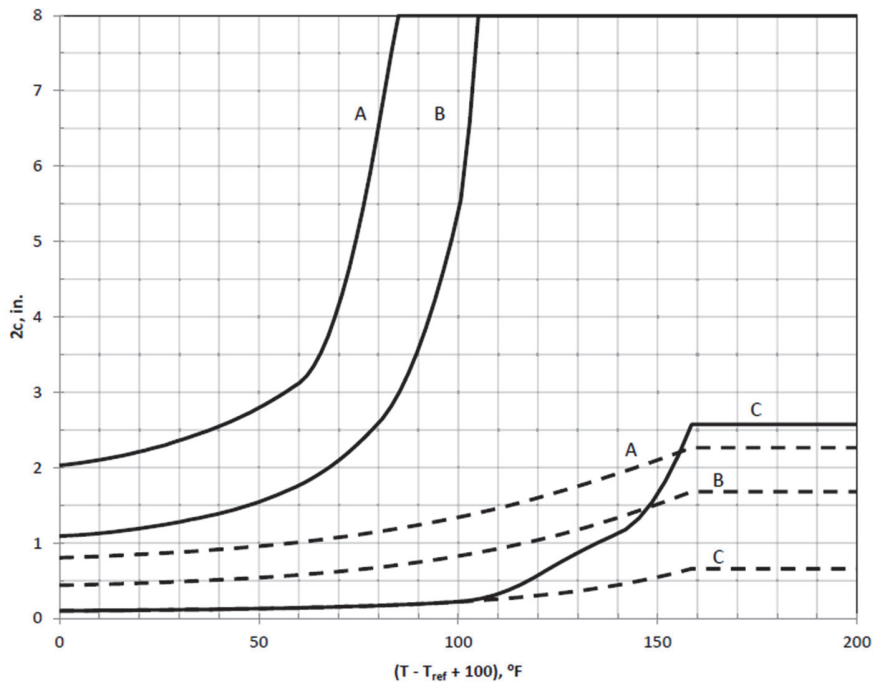

Figure B2: Determine the maximum allowance crack-like flaw length in cylinder, longitudinal joint, crack-like flaw parallel to the joint A) Allowable flaw size in base metal. B) Allowable flaw size in weld metal that has been subject to PWHT. C) Allowable flaw size in weld metal that has not been subject to PWHT- for each material solid line refers to 1/4- flaw, and dashed line refers to 1- flaw [5].

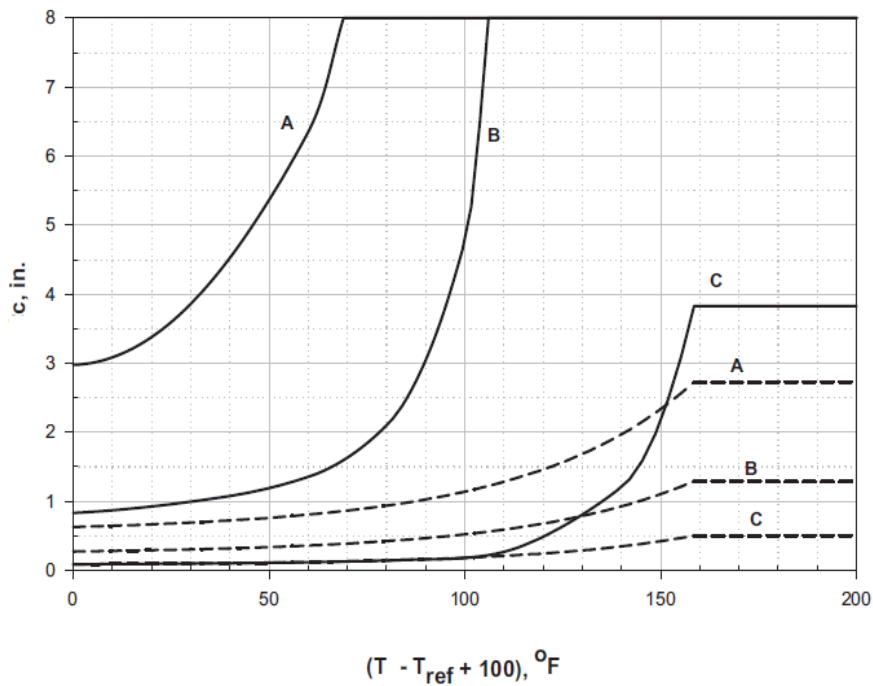

Figure B3: Determine the maximum allowance crack-like flaw length in cylinder, longitudinal joint, crack-like perpendicular to the joint A) Allowable flaw size in base metal. B) Allowable flaw size in weld metal that has been subject to PWHT. C) Allowable flaw size in weld metal that has not been subject to PWHT- for each material solid line refers to  $1/4-t$  flaw, and dashed line refers to  $1-t$  flaw [5].

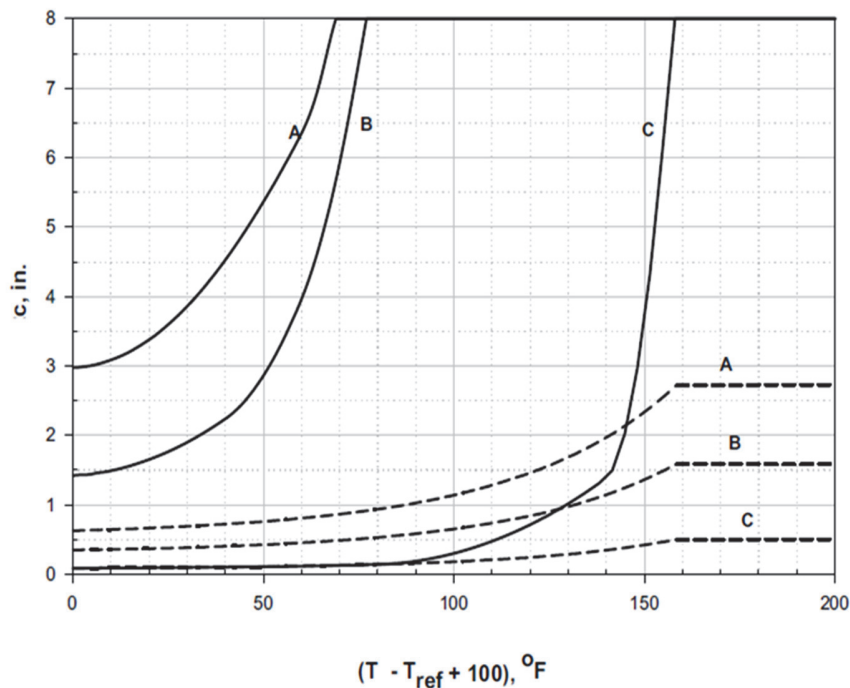

Figure B4: Determine the maximum allowance crack-like flaw length in cylinder, circumferential joint, crack-like parallel to the joint A) Allowable flaw size in base metal. B) Allowable flaw size in weld metal that has been subject to PWHT. C) Allowable flaw size in weld metal that has not been subject to PWHT- for each material solid line refers to  $1/4-t$  flaw, and dashed line refers to  $1-t$  flaw [5].

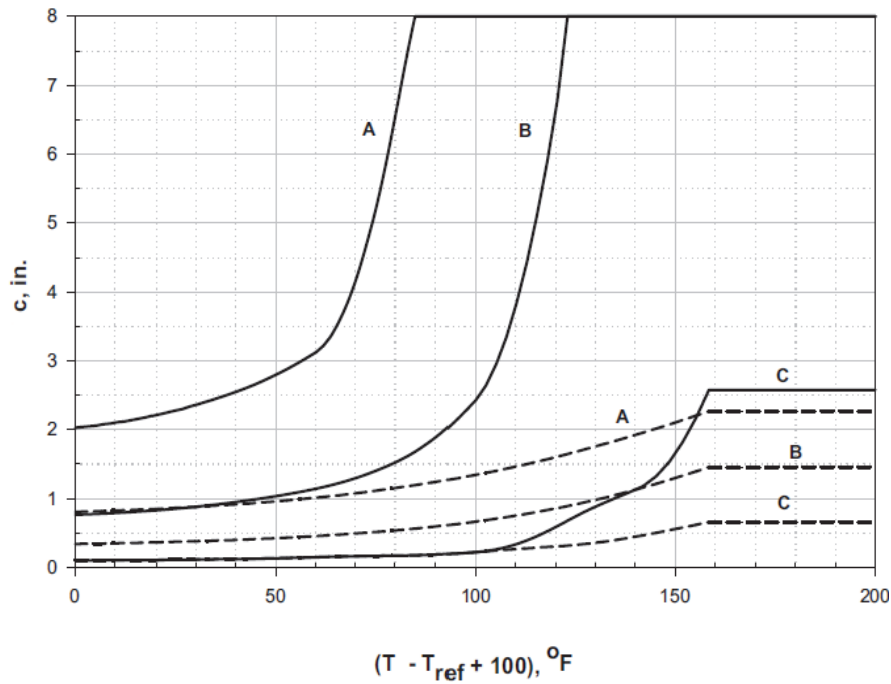

Figure B5: Determine the maximum allowance crack-like flaw length in cylinder, circumferential joint, crack-like flaw perpendicular to the joint A) Allowable flaw size in base metal. B) Allowable flaw size in weld metal that has been subject to PWHT. C) Allowable flaw size in weld metal that has not been subject to PWHT- for each material solid line refers to  $1/4$ -t flaw, and dashed line refers to 1-t flaw [5]

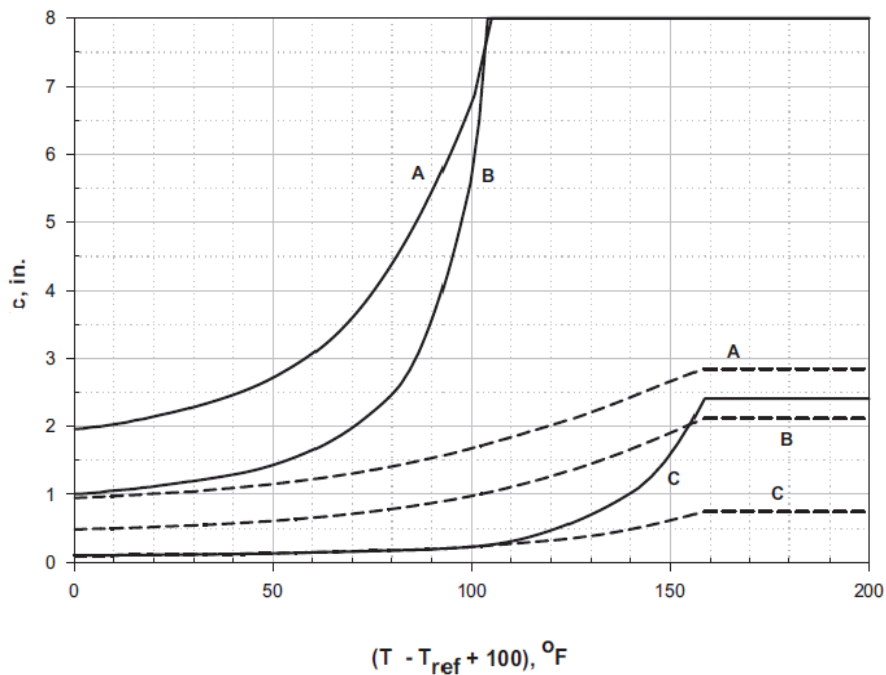

Figure B6: Determine the maximum allowance crack-like flaw length in sphere, circumferential joint, crack-like flaw parallel to the joint A) Allowable flaw size in base metal. B) Allowable flaw size in weld metal that has been subject to PWHT. C) Allowable flaw size in weld metal that has not been subject to PWHT- for each material solid line refers to  $1/4$ -t flaw, and dashed line refers to 1-t flaw [5].

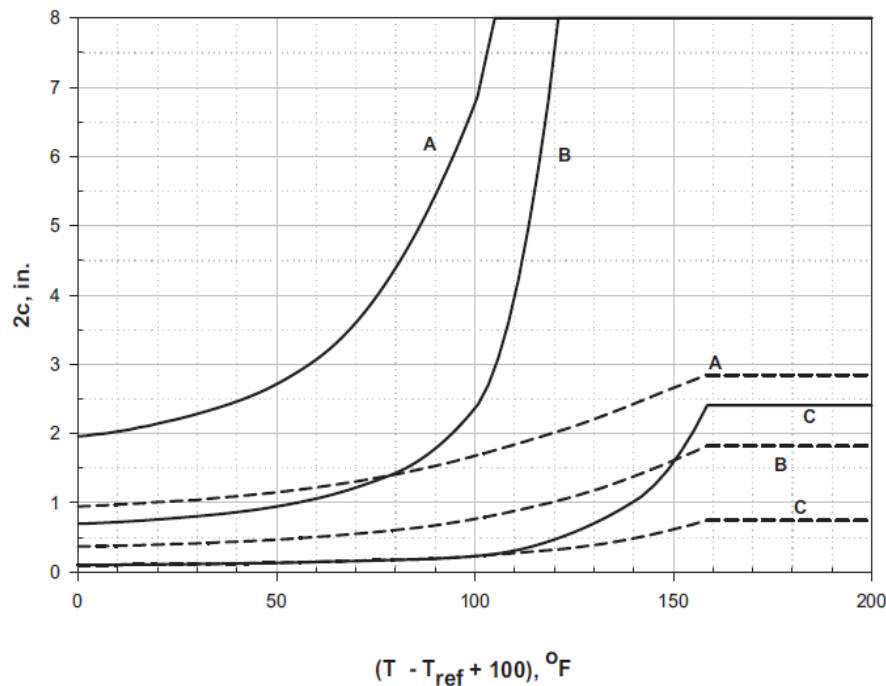

Figure B7: Determine the maximum allowance crack-like flaw length in sphere, circumferential joint, crack-like flaw perpendicular to the joint A) Allowable flaw size in base metal. B) Allowable flaw size in weld metal that has been subject to PWHT. C) Allowable flaw size in weld metal that has not been subject to PWHT- for each material solid line refers to 1/4-t flaw, and dashed line refers to 1-t flaw [5].

**Step 5:** Determine the reference temperature ( $T_{ref}$ ) and based on material specification (Table B1) and the minimum specified yield strength at ambient temperature (Table B2) is defined.

**Step 6:** Determine the maximum allowance crack-like flaw length based on Figures B1-B7.

**Step 7:** If the length of crack-like size less than or equal to permissible flaw size determine in Step 6, then the component is acceptable for future operation. Otherwise this level is not accepted.

The steps in Level 2 assessment is listed below [5]:

**Step 1:** Evaluate operating pressure, temperature and supplemental loading.

**Step 2:** Determine the location of the damage based on the applied stress and load distribution.

**Step 3:** Determine the yield strength and tensile strength for the operating condition.

**Step 4:** Determine the fracture toughness,  $K_{mat}$ , for the operating conditions.

**Step 5:** Determine the reference stress for primary stresses,  $\sigma_{ref}^P$ , based on the primary stress distribution and flaw size.

**Step 6:** Calculate the Load Ratio using the reference stress for primary loads and the yield strength.

$$L_r^P = \frac{\sigma_{ref}^P}{\sigma_{ys}} \quad (B1)$$

**Step 8:** Determine the stress intensity corresponds to the primary loads,  $K_I^P$ , and secondary load,  $K_I^{SR}$ , using the primary stress distribution and flaw size.

**Stage 9:** calculate following parameters based on equations B2-B7:

9-1: uniform plasticity interaction factor  $\Phi_0$ :

$$\Phi_0 = \left( \frac{a_{eff}}{w_H} \right)^{0.5} \quad (B2)$$



Curve	Material
<b>A</b>	<p>All carbon and all low alloy steel plates, structural shapes and bars not listed in Curves B, C, and D below. SA-216 Grades WCB and WCC if normalized and tempered or water-quenched and tempered; SA -217 Grade WC6 if normalized and tempered or water-quenched and tempered. The following specifications for obsolete materials: A7, A10, A30, A70, A113, A149, A150 (3). The following specifications for obsolete materials from the 1934 edition of the ASME Code, Section VIII: S1, S2, S25, S26, and S27 (4). A201 and A212 unless it can be established that the steel was produced by a fine-grain practice (5).</p>
<b>B</b>	<p>SA-216 Grades WCA if normalized and tempered or water-quenched and tempered. SA-216 Grades WCB and WCC for thicknesses not exceeding 2 inches if produced to a fine grain practice and water-quenched and tempered. SA -217 Grade WC9 if normalized and tempered. SA-285 Grades A and B SA-414 Grade A SA-442 Grade 55 &gt; 1 in. if not to fine grain practice and normalized. SA-442 Grade 60 if not to fine grain practice and normalized. SA-515 Grades 60 SA-516 Grades 65 and 70 if not normalized. SA-612 if not normalized. SA-662 Grade B if not normalized. Except for cast steels, all materials of Curve A if produced to fine grain practice and normalized which are not listed for Curve C and D below. All pipe, fittings, forgings, and tubing not listed for Curves C and D below. Parts permitted from paragraph UG-11 of the ASME Code, Section VIII, Division 1, shall be included in Curve B even when fabricated from plate that otherwise would be assigned to a different curve. A201 and A212 if it can be established that the steel was produced by a fine-grain practice.</p>
<b>C</b>	<p>SA-182 Grades 21 and 22 if normalized and tempered. SA-302 Grades C and D. SA-336 Grades F21 and F22 if normalized and tempered. SA-387 Grades 21 and 22 if normalized and tempered. SA-442 Grades 55 &lt; 1 in. if not to fine grain practice and normalized. SA-516 Grades 55 and 60 if not normalized. SA-533 Grades B and C. SA-662 Grade A. All material of Curve B if produced to fine grain practice and normalized and not listed for Curve D below. SA-203. SA-442 if to fine grain practice and normalized. SA-508 Class 1. SA-516 if normalized. SA-524 Classes 1 and 2. SA-537 Classes 1 and 2. SA-612 if normalized. SA-662 if normalized. SA-738 Grade A.</p>
<b>D</b>	

Table B1: Determining curve type based on material specifications [5]



Carbon Steel				
MYS (Ksi)	A F	B F	C F	D F
30	104	66	28	2
32	97	59	21	-5
34	91	53	15	-11
36	86	48	10	-16
38	81	43	5	-21
40	78	40	2	-24
42	74	36	-2	-28
44	71	33	-5	-31
46	68	30	-8	-34
48	66	28	-10	-36
50	63	25	-13	-39
Low Alloy Steel				
MYS (Ksi)	A F	B F	C F	D F
30	124	86	48	22
32	115	77	39	13
34	107	69	31	5
36	101	63	25	-1
38	96	58	20	-6
40	92	54	16	-10
42	88	50	12	-14
44	85	47	9	-17
46	81	43	5	-21
48	79	41	3	-23
50	76	38	0	-26
52	71	35	-3	-29
54	69	33	-5	-31
56	67	31	-7	-33
58	65	29	-9	-35
60	63	27	-11	-37
62	62	25	-13	-39
64	60	24	-14	-40
66	58	22	-16	-42
68	57	20	-18	-44
70	56	19	-19	-45
72	54	18	-20	-46
74	53	16	-22	-48
78	52	15	-23	-50
80	51	13	-25	-51

Table B2: Determining  $T_{ref}$  based on the material and minimum yield strength (MYS) [5]

$$a_{eff} = a + \left(\frac{1}{6\pi}\right) \cdot \left(\frac{K_I^{SR}}{\sigma_{ys}}\right)^2 \quad \text{Plane Strain Conditions} \quad (B3a)$$

$$a_{eff} = a + \left(\frac{1}{2\pi}\right) \cdot \left(\frac{K_I^{SR}}{\sigma_{ys}}\right)^2 \quad \text{Plane Stress Conditions} \quad (B3b)$$

9-2: corrected stress intensity factor for secondary and residual stresses for plasticity effects:





$$K_J^{SR} = \Phi_0 \cdot K_I^{SR} \tag{B4}$$

9-3: parameter X :

$$X = K_J^{SR} \cdot \left( \frac{L_r^P}{K_I^P} \right) \tag{B5}$$

9-4: plasticity interaction factor  $\Phi$  :

$$\Phi = \Phi_0 \cdot \xi \tag{B6}$$

Where  $\xi$  is determined based on Table B3.

$L_r^P$	X																		
	0	0.02	0.04	0.06	0.08	0.1	0.2	0.3	0.4	0.5	1	1.5	2	2.5	3	3.5	4	4.5	
0	1	1	1	1	1	1	1	1	1	1	1	1	1	1	1	1	1	1	
0.01	1	1.000	1.000	1.000	1.000	1.000	1.001	1.001	1.002	1.003	1.011	1.019	1.023	1.026	1.028	1.029	1.030	1.031	
0.02	1	1.000	1.000	1.001	1.001	1.001	1.002	1.003	1.004	1.006	1.019	1.031	1.038	1.042	1.044	1.046	1.048	1.051	
0.03	1	1.001	1.001	1.001	1.001	1.002	1.003	1.004	1.006	1.008	1.026	1.04	1.048	1.053	1.056	1.059	1.06	1.061	
0.04	1	1.001	1.001	1.001	1.002	1.002	1.004	1.006	1.008	1.011	1.031	1.047	1.056	1.061	1.065	1.068	1.071	1.076	
0.06	1	1.002	1.002	1.003	1.003	1.004	1.006	1.009	1.012	1.016	1.039	1.058	1.068	1.074	1.078	1.083	1.087	1.092	
0.08	1	1.002	1.003	1.004	1.004	1.005	1.008	1.012	1.016	1.02	1.045	1.066	1.077	1.084	1.088	1.093	1.098	1.103	
0.1	1	1.004	1.004	1.005	1.006	1.007	1.011	1.015	1.02	1.024	1.05	1.072	1.084	1.092	1.097	1.102	1.108	1.114	
0.12	1	1.005	1.006	1.007	1.008	1.009	1.013	1.018	1.023	1.028	1.054	1.077	1.09	1.099	1.104	1.11	1.116	1.122	
0.14	1	1.007	1.008	1.009	1.01	1.011	1.016	1.022	1.027	1.032	1.057	1.082	1.096	1.105	1.111	1.117	1.123	1.131	
0.16	1	1.008	1.010	1.011	1.012	1.013	1.019	1.025	1.031	1.035	1.06	1.086	1.101	1.111	1.117	1.123	1.13	1.138	
0.18	1	1.010	1.012	1.013	1.014	1.016	1.022	1.029	1.034	1.038	1.063	1.09	1.106	1.116	1.124	1.129	1.137	1.145	
0.2	1	1.012	1.014	1.015	1.017	1.018	1.026	1.033	1.038	1.041	1.066	1.094	1.11	1.121	1.128	1.136	1.144	1.153	
0.3	1	1.027	1.029	1.031	1.033	1.035	1.045	1.051	1.054	1.055	1.08	1.113	1.133	1.146	1.155	1.165	1.175	1.187	
0.4	1	1.049	1.052	1.054	1.057	1.059	1.068	1.071	1.071	1.071	1.099	1.135	1.157	1.173	1.184	1.196	1.209	1.225	
0.5	1	1.082	1.085	1.087	1.089	1.091	1.096	1.096	1.095	1.095	1.126	1.164	1.187	1.203	1.215	1.229	1.246	1.266	
0.6	1	1.126	1.128	1.129	1.13	1.131	1.131	1.129	1.128	1.129	1.161	1.196	1.218	1.234	1.248	1.262	1.284	1.311	
0.7	1	1.176	1.175	1.175	1.175	1.174	1.171	1.169	1.168	1.169	1.195	1.224	1.242	1.256	1.269	1.288	1.314	1.343	
0.8	1	1.215	1.214	1.212	1.211	1.21	1.204	1.20	1.198	1.196	1.21	1.228	1.241	1.252	1.267	1.291	1.316	1.341	
0.9	1	1.215	1.212	1.210	1.208	1.206	1.198	1.191	1.185	1.180	1.178	1.184	1.190	1.199	1.218	1.24	1.269	1.271	
1	1	1.133	1.13	1.128	1.125	1.123	1.112	1.102	1.094	1.087	1.07	1.067	1.069	1.08	1.09	1.105	1.104	1.094	
1.1	1	0.951	0.948	0.946	0.943	0.941	0.93	0.921	0.912	0.905	0.884	0.877	0.882	0.887	0.879	0.861	0.842	0.82	
1.2	1	0.710	0.708	0.707	0.707	0.703	0.695	0.688	0.682	0.677	0.661	0.658	0.649	0.633	0.613	0.597	0.583	0.571	
1.3	1	0.498	0.497	0.496	0.495	0.494	0.490	0.486	0.483	0.480	0.471	0.461	0.449	0.439	0.439	0.427	0.420	0.415	
1.4	1	0.376	0.375	0.375	0.375	0.374	0.373	0.371	0.37	0.368	0.361	0.359	0.358	0.357	0.355	0.354	0.351	0.351	
1.5	1	0.334	0.334	0.333	0.333	0.333	0.332	0.331	0.331	0.33	0.33	0.331	0.332	0.333	0.332	0.333	0.331	0.333	
1.6	1	0.320	0.319	0.319	0.319	0.319	0.318	0.318	0.317	0.317	0.317	0.319	0.32	0.321	0.32	0.32	0.322	0.319	
1.7	1	0.308	0.308	0.308	0.308	0.308	0.307	0.307	0.306	0.306	0.306	0.307	0.308	0.309	0.309	0.308	0.309	0.308	
1.8	1	0.296	0.296	0.296	0.296	0.296	0.295	0.295	0.294	0.294	0.294	0.295	0.296	0.296	0.295	0.297	0.295	0.297	
1.9	1	0.283	0.283	0.283	0.283	0.282	0.282	0.282	0.281	0.281	0.281	0.281	0.282	0.282	0.284	0.283	0.281	0.280	
2	1	0.268	0.268	0.268	0.268	0.268	0.267	0.267	0.267	0.266	0.266	0.266	0.266	0.266	0.262	0.261	0.256	0.263	

Table B3: Plasticity Interaction Factor – Parameter  $\xi$  as a Function of  $L_r^P$  and X [5].

9-5: toughness ratio or ordinate of the FAD assessment point:



$$K_r = \frac{K_I^P + \Phi \cdot K_I^{SR}}{K_{mat}} \quad (B7)$$

**Step 10:** Plot the point on the Failure Assessment Diagram (FAD) in Figure B8. If the point is below or on the FAD the Level 2 assessment is acceptable otherwise this level is not approved.

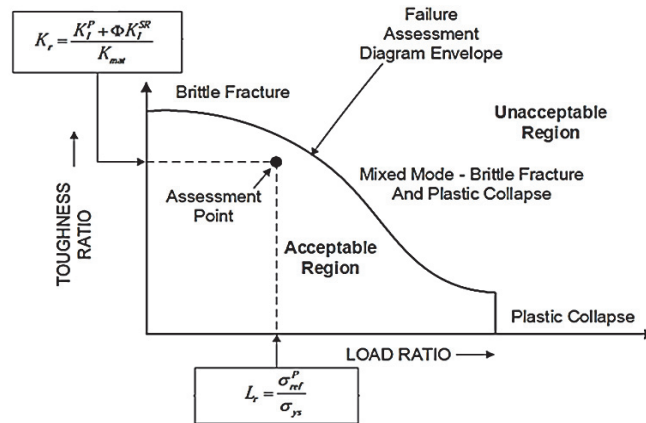

Figure B8: Evaluating FAD assessment point for the operating stress condition and flaw size [5].

## Nomenclature

$a_{eff}$	Effective depth of the crack
$c$	HIC damage size in the circumferential direction
$CET$	Critical Exposure Temperature
$D$	Inside diameter of the cylinder
$D_H$	HIC Damage parameter correlated to the strength of steel with HIC damaged steel to that of undamaged steel.
$E$	Weld joint efficiency or quality factor from the construction Code, if unknown use 0.7.
$FCA$	Future corrosion allowance based on uniform corrosion metal loss.
$H_f$	Distance between the bottom of the flaw and the tank bottom.
$K_I^P$	Stress intensity corresponds to the primary loads.
$K_I^{SR}$	Stress intensity corresponds to the secondary loads.
$K_J^{SR}$	Corrected stress intensity factor for secondary and residual stresses for plasticity effects.
$K_{mat}$	Fracture toughness
$K_r$	Toughness ratio
$L_{DC}$	Limit load of the the component with damage



---

$L_H$	HIC spacing to the nearest HIC and/ or blister damage from edge-to-edge
$L_{Hc}$	Distance of HIC damage to nearest HIC or blister in the circumferential direction.
$L_{Hs}$	Distance of HIC damage to nearest HIC or blister in the longitudinal direction
$L_{msd}$	Distance of HIC damage to nearest major structural discontinuity.
$L_R$	Amount of non-damaged material available for propagation of the HIC damaged area
$L_r^P$	load ratio based on primary stress
$L_{UC}$	Limit load of the component without damage.
$L_w$	Distance of HIC damage to nearest weld joint
LOSS	Amount of uniform metal loss during inspection
$M_t$	Folias factor
MAWP	Maximum allowable working pressure of the undamaged component
MAWP <sup>C</sup>	Maximum allowable working pressure based on circumferential stress.
MAWP <sup>L</sup>	Maximum allowable working pressure based on Longitudinal stress.
MAWP <sub>r</sub>	Reduced maximum allowable working pressure of the component with HIC damage.
MFH	Maximum Fill Height
MFH <sub>r</sub>	Reduced maximum fill height
RSF	Remaining strength factor
RSF <sub>a</sub>	Allowable remaining strength factor.
$s$	HIC or blister size in the longitudinal direction
$S$	Allowable Stress
$t_c$	Corroded wall thickness
$t_{min}$	Minimum required thickness
$t_{min}$	Minimum required thickness
$t_{min}^C$	Minimum required thickness based on circumferential membrane stress
$t_{min}^L$	Minimum required thickness based on the longitudinal membrane stress
$t_{mm}$	Minimum measured thickness of undamaged metal the HIC

---



$t_{mm-ID}$	Minimum measured thickness of undamaged metal on the internal side of HIC damage
$t_{mm-OD}$	minimum measured thickness of undamaged metal on the external side of HIC damage
$t_{nom}$	Nominal thickness of the component accustomed for mill under tolerance as applicable.
$t_{rd}$	Uniform thickness away from the damage area at the time of the inspection.
$t_{sl}$	Supplemental thickness required for the loads other than pressure that result in longitudinal stress
$w_H$	HIC damage's depth as measured in the through-thickness direction
X	Parameter used in the calculation of plasticity correction factor
$\sigma_{ref}^P$	Reference stress for primary stresses
$\sigma_{ys}$	Yield strength at the assessment temperature
$\Phi_0$	Uniform plasticity factor
$\Phi$	Plasticity Factor
$\lambda$	Longitudinal flaw length parameter.