

Commissioning and quality assurances of the Intrabeam Intra-Operative radiotherapy unit

KR Muralidhar¹, Birendra Kumar Rout², Adavala Mallikarjuna², A Poornima², P Narayana Murthy³

¹Department of Radiation Physics, American Oncology Institute Nallagandla, Lingampally, Hyderabad, India

²Department of Radiation Physics, Indo-American Cancer Institute, Hyderabad, India

³Department of Radiation Physics, Nagarjuna University, Guntur, India

Received August 20, 2014; Revised October 15, 2014; Accepted October 19, 2014; Published Online October 20, 2014

Original Article

Abstract

Purpose: The authors report comprehensive commissioning and quality assurance (QA) procedures for Intrabeam, Intra-Operative radiotherapy (IORT) unit. The Intrabeam system miniature X-ray source is a 50 kV and 40 μ A unit. **Methods:** The authors' tests include measurements of output, beam deflection, isotropy, kVp and mAs measurements, quality index, isodose, reproducibility, linearity, depth dose verification, and 3D dose distribution. IC ionization chamber and the UNIDOSE dosimeter were used for the output commissioning. Probe adjuster/ionization chamber holder (PAICH) was used to check the mechanical straightness of the probe. For radiation tests, NACP parallel plate chamber, Standard Imaging electrometer, 30 \times 30 \times 30 cm³ IAEA water phantom, solid water slabs, EDR-2 Films with RIT software, and ionization based survey meters were used. Unfors Xi platinum edition kVp meter was used to measure the kVp and mAs. **Results:** In mechanical QA test, X-Beam position (-0.09 mm), Y-Beam position (0.01 mm), and radial position (0.11 mm) errors were within the tolerance level. Isotropy test with PDA, survey meter, ion chamber, and film measurements also produced results within the specifications. Output measurements with PAICH and external chamber measurements were matched. Beam quality, linearity, and reproducibility values were ascertained at 50KV and 40 μ A and found to be within limits. Isodose, 3D dose distribution, transverse, and horizontal profiles showed the good isotropy of the source. **Conclusion:** The authors' methodology provides comprehensive commissioning and calibration procedures for the Intrabeam system.

Keywords: IORT; Intrabeam; X-Ray Source; Isotropy; Photo Diode Array

Introduction

Intrabeam system (Carl Zeiss Surgical GmbH, Oberkochen, Germany) is a mobile unit used for Intraoperative Radiotherapy (IORT), especially for localized tumor irradiation and for sharp fall of dose from the source. The heart of this system is a miniature with high dose rate and low energy X-ray source (XRS) equipped with a 10 cm long (ϕ 3.2 mm) probe. The tip of the XRS probe is placed into a lesion or a tumor bed. It is a truly flexible system for IORT. The Intrabeam delivers treatment by a number of methods, including intraoperative, interstitial, intra-cavity, and surface treatments. In IORT facility, the quality assurance needs to be more stringent due to miniature x-ray source and its high dose rate.¹⁻² Since Intrabeam system installed at our center was the first of its kind in India, various quality assurance procedures and radiation safety issues were to be addressed at the time of commissioning both from regulatory as well as operational standpoints.

While a number of reports exist describing the quality assurance for IORT, very few papers deal with the QA aspects in detail. These tests (mechanical, dynamic offset, isotropy test with photodiode array (PDA), and probe adjuster/ionization chamber holder (PAICH) output check (dose rate)) are well evaluated as part of the commissioning process; however, there is no discussion about the complementary procedures to ensure its clinical use. In this study, after commissioning the system by measuring the parameters proposed by the manufacturer, a number of procedures have been proposed before the system can be applied in clinical use. These tests (beam quality test, linearity test, and reproducibility test, isotropy test with survey meter and EDR-2 film, external kVp and mAs measurements, isodose and depth dose measurements with film) were complementary procedures to check the correct installation and calibration. The use of proposed parameters might be helpful to check if doses are correctly delivered from the system measurement using a tank of water. Another interesting test is to obtain the

Corresponding author: KR Muralidhar; Department of Radiation Physics, American Oncology Institute Nallagandla, Lingampally, Hyderabad, India.

Cite this article as: Muralidhar KR, Rout BK, Mallikarjuna A, Poornima A, Murthy PN. Commissioning and quality assurances of the Intrabeam Intra-Operative radiotherapy unit. *Int J Cancer Ther Oncol* 2014; 2(4):020415. DOI: 10.14319/ijcto.0204.15

A part of this research was presented at Standards, Applications and Quality Assurance in Medical Dosimetry, which was held in Nov 2010 at IAEA, Vienna

transverse and horizontal profile information and 3D dose distribution using RIT software with EDR-2 films. All these tests make sure that the system is within the manufacturer specified values and further improve this technology towards dedicated computerized planning system. The main purpose of this study was to create enough confidence on the Intra-beam system by performing additional quality assurances as specified by the authors.

Methods and Materials

Intrabeam operation

This Photon Radio surgery system (PRS) comprises an XRS [Figure 1], PRS 500 control console, quality assurance tools, and mobile gantry.



FIG. 1: Intra-beam system.

The miniature X-ray source [Figure 2] is a 50 kVp and 40 μ A unit capable of delivering 1.32 mGy/min at 1 meter from the source.

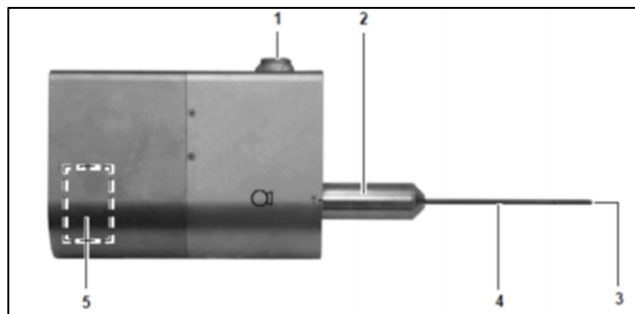

FIG. 2: X-ray source with internal radiation monitor (IRM): (1) XRS-4 cable connector, (2) Beam deflector, (3) Probe tip, (4) X-ray probe, and (5) IRM (courtesy Carl Zeiss)

High voltage is generated by the XRS from the low direct current voltage supplied by the PRS 500 control console, and is used to direct an electron beam into the X-ray probe. The electron beam strikes a hemispherical gold target, approximately 1 μ m thickness at the end of the X-ray probe,

generating X-radiation.³ The X-ray system produces low-energy photons (30-50 kVp) with a steep dose falloff in soft-tissue; hence, no special shielding is required in the room. The production of an x-ray pattern is spherical in shape about the tip of the drift tube. Adjustment of beam steering and the angle of precession allow the isotropic distribution to be optimized.⁴ The probe tip is made of beryllium (Be), a material transparent to X-radiation. The exterior surface of the XRS probe is provided with a protective coating.

In order to use the XRS, it must be connected to the PRS 500 control console with the XRS interface cable. X-radiation produced at the tip of the X-ray probe features a spherical radiation characteristic. As a result, part of the radiation re-enters the XRS through the probe. The IRM detects this X-radiation in the XRS. The radiation output measured by the IRM is then used during treatment as an indirect measure of radiation delivered at the probe tip. There are few important tests that should be covered prior to clinical use of this unit. These tests typically include the mechanical and radiation measurements. The PRS is supplied with a set of components, which facilitate accurate alignment of the XRS probe as well as quality assurance checks.⁵

Mechanical Tests

Mechanical straightness check of the probe is very important. For this test, probe adjuster/ionization chamber holder (PAICH) can be used. Performing this verification step is must if the isotropy verification is unsuccessful or the XRS probe is suspected to be bent. Specifically, in order to check the mechanical straightness, the probe should be inserted into the PDA (Photo Diode Array), and the PAICH and the XRS need to be connected to the control console using the appropriate cables. After successful cable connection, rotate the PAICH completely to 360° or less to measure the highest value of deviation. The plunger is then depressed and released to straighten the XRS probe. This procedure is repeated until the Run out value is less than 0.10 mm.

Radiation Tests

In our study, inbuilt radiation tests (alignment (probe adjuster), steering (quick check, dynamic offsets), Isotropy and IRM (PDA), Output (PAICH)) were done to check the dynamic offset, isotropy, and dose rate. New quality assurances (beam quality test, linearity test, and reproducibility test, isotropy test with survey meter and EDR-2 film, external kVp and mAs measurements, isodose and depth dose measurements with film) were done by using film, ionization chamber, survey meter, kVp, and mAs meter.

Dynamic Offset

This technique is used to align the direction of the electron beam with the mechanical center of the XRS probe by beam deflection adjustment. The XRS and PDA photodiode array were aligned with the help of +X and +Y markings on them

and were connected to control console using the appropriate cables. In the system calibration procedure, adjustment was performed automatically for the selected XRS source at a specific high voltage.

Isotropy test with PDA

The PDA was used to measure and, if needed, to adjust the isotropy of the radiation emission from the XRS probe tip. The PDA incorporates five photodiodes, placed in a centered position on the four side faces and the top face of a cube, such that all are equidistant from the center of radiation of the XRS probe tip. The signals from the PDA were displayed in the screen mask and were used to measure the distribution (isotropy) of X-radiation emitted from the tip of the probe. The isotropy of the radiation field was automatically adjusted on the basis of these measured values. The *Isotropy Adjust* procedure was performed using the maximum beam current and the same beam voltage that was selected for the relevant XRS.

PAICH Output Check (dose rate)

This procedure is used to determine the dose rate of the XRS by means of the inbuilt ionization chamber and the UNIDOSE dosimeter. The dose rate was checked against a specific expected value from the calibration data given by the manufacturer. To perform this test, the PAICH was attached to the XRS. Ionization chamber was then inserted into the holder of PAICH and connected to the dosimeter. The output dose rate value indicated in Gy/min is the value computed internally.

Beam Quality test

Dose rates were measured at 5 cm and 3 cm distances from the cone in the water phantom [Figure 3] for three days with 0.6 CC ionization chamber (IBA Dosimetry GmbH, Germany). The measured dose rate values were used to verify the energy stability. Dose gradients are typically steep within 2 cm distance from the source. In order to avoid the uncertainties, it is always advisable to take the readings at greater than 3 cm.

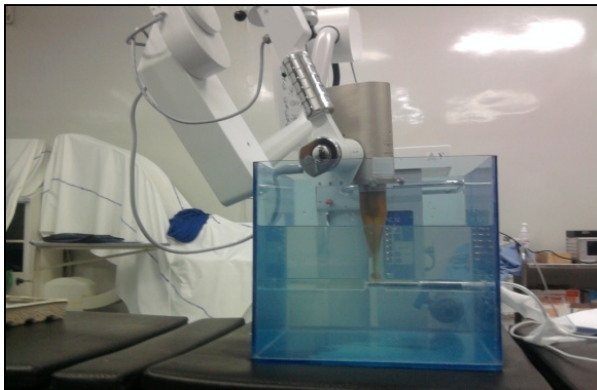

FIG. 3: Measurements in water phantom.

Depth dose measurement

Depth-dose curves were obtained by measuring the ionization chamber output at distances between 1 to 10 cm away from the probe tip in a water phantom of dimensions $30 \times 30 \times 30 \text{ cm}^3$. The ionization chamber was placed at the center of the phantom in the Perspex enclosure. The position of the x-ray source is shown in the **Figure 3**. Care was taken to maintain the straightness of the probe. The minimum distance away from the probe tip at which the ionization chamber could be positioned was 10 mm from the center of the chamber. We acquired depth dose data in water to reduce the uncertainties involved in converting from an air measurement to the measurement in water. Additionally, a comparison was made between the measured depth doses and corresponding values obtained from the manufacturer.¹

Linearity Test

The linearity of the intrabeam system was ascertained at 50 kVp and 40 μA for the range of 1 to 5 minutes. Measurements were taken at 4 cm distance from the source with parallel plate ionization chamber.

Reproducibility Test

Reproducibility of the x-ray output was investigated for intrabeam under 10 exposures. Each exposure was controlled using a preset timer. A beam voltage of 50 kVp and beam current of 40 μA were used. Ten measurements were made for exposures equivalent to 1 minute each at a distance of 4 cm from the surface in water phantom.

Isotropy test with the survey meter

In this study, x-ray radiation was measured in a series of square projections from x-ray source by means of an ion chamber based survey meter. Isotropy was estimated with the help of the obtained data. This is one of the simple procedures to check the isotropy of the system.

Isotropy test with EDR-2 film and RIT software

Five EDR-2 films were used to test the isotropy of the source. All films were kept at 5 cm from the source in five directions (0° , 90° , 180° , 270° , and perpendicular to the source). Five exposures, each of one minute duration were made. The exposed films were scanned in Vidar film scanner and analyzed using Radiological Imaging Technology (RIT[®]) Software. This software provides precise QA analysis for images from many different sources (CT, X-ray, etc.). The difference between the horizontal and vertical profiles gives the dose difference at any given point in that particular plane. A good isotropy shows the negligible difference between these two profiles. If the difference is significant ($>1\%$), mechanical test and dynamic offset test should be done to get the good isotropy.

Isodose and depth dose measurements with film

Isodose measurements were done by exposing the film vertically down from the source. Film analysis was done by RIT software and percentage depth doses were obtained by normalizing the values at 2 cm depth from the surface where the output was compared with an ionization chamber.

External kVp and mAs measurements

Unifors Xi platinum edition kVp meter was used to study the kVp measurement. To measure the kVp, the setup was such that the IORT Cone positioned vertically on the surface of the kVp meter. This kVp meter was connected to the personal computer with loaded software which shows the readings continuously in digital and wave form. Measurements were taken with few exposures.

Results

Mechanical Test

Distance from the tip of the drift tube was measured and compared with the stated length. Geometric accuracy depends upon the variation between these two values. The maximum variation of the drift tube from its longitudinal axis was found to be less than 0.08 mm. This verification test is passed by succeeding in centering the XRS Probe to a run out of the maximum deviation of value less than 0.10 mm.

Radiation Tests

Dynamic Offset

The X, Y, and radial beam position errors were ± 0.1 mm according to manufacturer recommended value (< 0.1 mm)

Isotropy test with PDA

The measurements for the five bars were ranged from 5.7 to 5.75, and these values were within the tolerance level.

PAICH Output Check (dose rate)

Readings on the UNIDOS® E dosimeter displayed the dose rate values. The maximum % of variation with the calibrated value was less than 2% observed.

Beam Quality

The measured quality indexes for three consecutive days were 0.312, 0.313, and 0.310, respectively, which proved that the system has good energy stability [Table 1]. The $d5/d3$ is the ratio of the meter readings at depth 5 cm and 3 cm, respectively.

TABLE 1: Quality index Intra-beam System.

Day	d5/d3	Quality index
1 st Day	0.714 / 2.286	0.312
2 nd Day	0.715 / 2.284	0.313
3 rd Day	0.710 / 2.289	0.310

Depth dose Measurement

Sharp dose fall off (approximately $1/r^3$) in water was observed [Figure 4] with respect to the depth. These measurements satisfied the values obtained by Carl zeiss³ calibrated values.

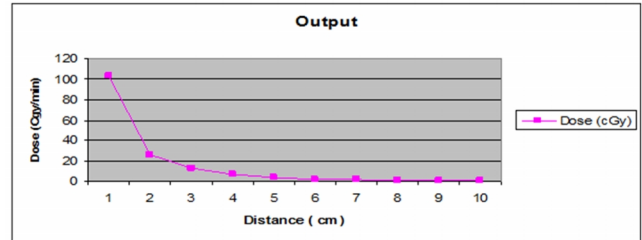

FIG. 4: Output measurement.

Linearity test

For all five readings, plot of dose measured versus exposure time was found to be linear [Figure 5]. In all the exposures, the ionization chamber distance was 4 cm from the source in the water phantom.

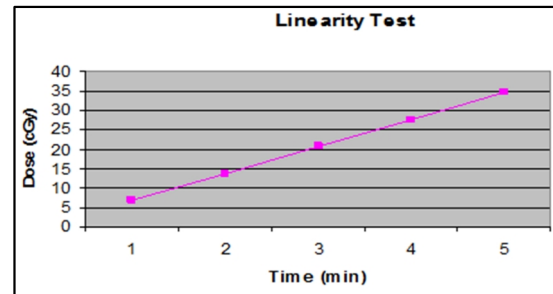

FIG. 5: Linearity test.

Reproducibility

The measurements of reproducibility were carried out for ten measurements as shown in [Figure 6]. We observed that the reproducibility was, in terms of mean deviation, better than 0.44%.

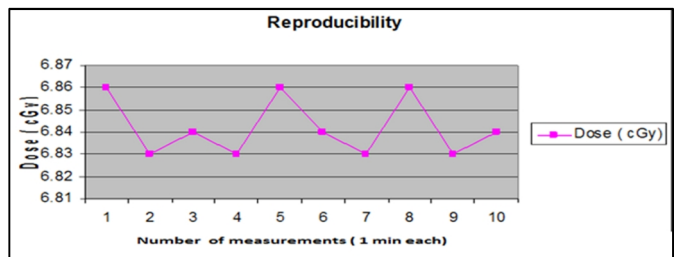

FIG. 6: Reproducibility.

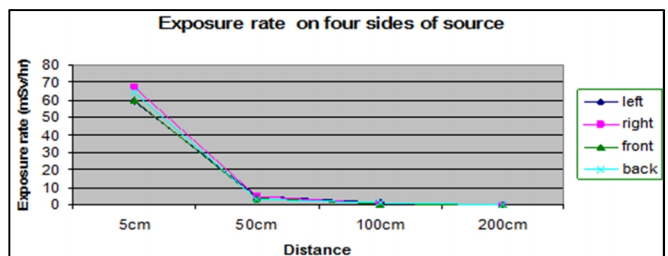

FIG. 7: Exposure rate measurements.

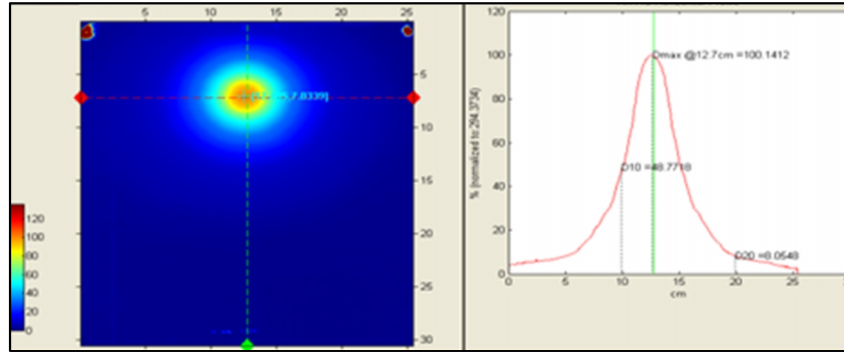

FIG. 8: Isotropy check with EDR-2 Films and RIT software.

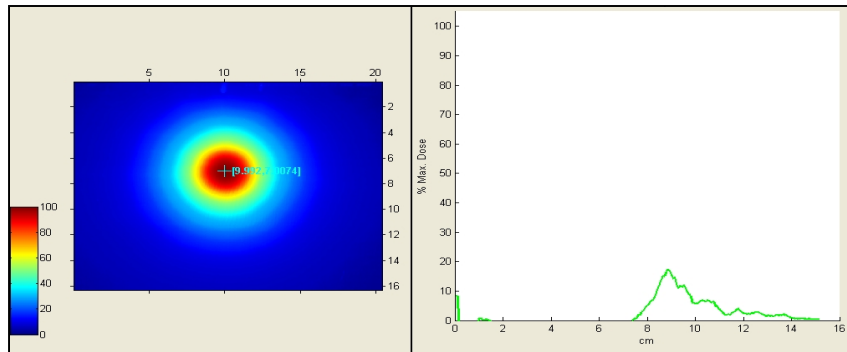

FIG. 9: Difference between horizontal and vertical profile.

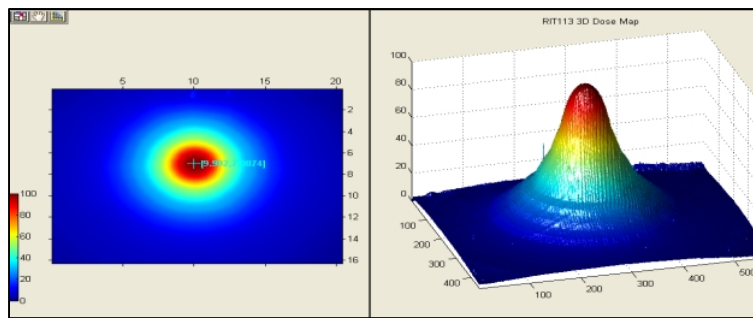

FIG. 10: 3D View of the IORT dose distribution.

Isotropy check with survey meter

Exposure rates in different directions have shown almost similar results. The reading of the survey meter at 5 cm, 50 cm, 100 cm, and 200 cm from the source were taken in four directions and analyzed with graph. Figure 7 shows the good isotropy along with the radiation safety in Operation Theatre itself.

Isotropy check with EDR-2 Film

The analysis of EDR-2 films with RIT shows an excellent isotropy. The isodose measured in all directions are at the same distance from the source center. Inline and cross line measurements are also shown in the Figure 8.

With the help of inline and cross line profiles, we can find the dose difference between either sides of the source at the

same distance. The difference in dose at 2 cm and 12 cm distance from the center of the exposure were 1.7% and 0.7 %, respectively. In one typical case, the difference between horizontal and vertical profiles were analyzed through RIT software as shown in Figure 9. The 3D dose distribution also gives us the clear view of the isotropy through RIT software as shown in Figure 10.

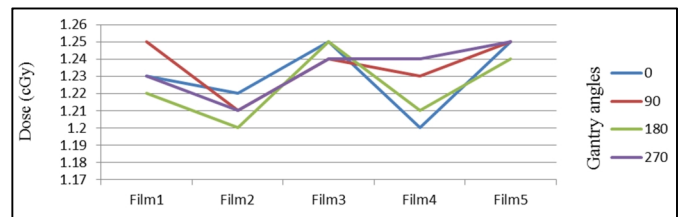

FIG. 11: Analysis of EDR2 films after exposing with IORT source.

The **Figure-11** clearly shows the values which proved that the system displays good isotropy. The maximum % of difference in dose between films in all directions was 4% and the difference between maximum dose deposited on each film was 0.5%.

Isodose and depth dose measurements with film

Depth doses and isodoses were derived through film measurements [**Figure 12**]. The dose rate was normalized to 100% at 2 cm depth in the film to simulate the water phantom depth doses, which were used for the output measurements. It was found through film measurements that the beam attenuation varies by $1/r^3$ as provided by the manufacturer. This concept can be implemented on CT planning in the treatment planning system.

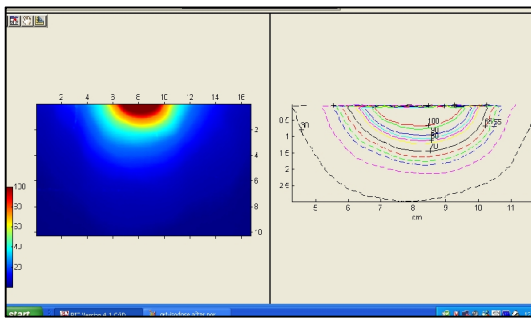

FIG. 12: Isodose curves from film measurements.

External kVp and mAs measurements

Reading for one minute exposure was taken for four times and the deviations were observed. These values closely resembles with the value (50 kVp) that was kept inside the console (PRS500). The maximum and minimum of variation in percentage were 2% and 0.8%, respectively.

Discussion

In the past ten years, there has been an increasing interest in the IORT technique because of the development of mobile accelerators⁶⁻⁸ producing only electron beams. Clinical use of IORT, given as a single fraction, was tested using electrons (Intraoperative Radiotherapy with Electrons [ELIOT])⁹, brachytherapy¹⁰, or low-energy X-rays (Targeted Intraoperative Radiation Therapy [TARGIT]).¹¹ It is, however, important to appreciate the different characteristics of the applicators and take advantage of its special features.¹² Intraoperative radiotherapy is useful for giving high radiation to the tumor, and at the same time, it spares the normal structures with the ability to stop radiation with less penetration because 50 keV energy is increasingly popular, especially among intact breast cases. Installation, commissioning, and operation of this equipment are limited across the globe as they have been in use for last few years. We have recently installed this machine. As it is a very delicate apparatus, care

should be taken to handle the source and other equipments associated with this device.

In built quality assurance procedures should be done to start the exposure.¹³ This is a very good feature for the accurate treatment. From the radiation safety point of view, there were no issues as it is 50 keV and 40 μ A machine, and it is also very easy to handle because the dose decreases steeply with the radial distance, r (approximately proportional to r^3). For every month, over one year period, we observed a deviation of baseline values for output, isotropy, and mechanical straightness of the probe to be less than $\pm 1\%$. This compares favorably with the output constancy of $\pm 2\%$ recommended by the European Commission in 1997.¹⁴

Conclusion

We have summarized the simple QA procedures to test the various parameters of the IORT unit (50 keV, 40 μ A). The output measurement with ion chamber, kVp Meter, isotropy measured with EDR films and survey meter were matched perfectly with the inbuilt quality assurance measurements. Percent depth dose measurements were found to be in very good agreement with the manufacturer given data after normalization.

Furthermore, the IORT generally comes with manufacturer recommended tests to check the quality of the device. It is very important to verify the isotropy, kVp and mAs measurements, quality index, isodose, reproducibility, linearity, depth dose measurements, and 3D dose distribution along with manufacturer recommended tests. In conclusion, uniform irradiation was proved and checked frequently in the sphere of equivalence which defines a novel target volume with low energy x-rays. The measurement techniques presented in this study are helpful to verify the manufacturer recommended values and to implement QA procedures with high accuracy at the institution.

Conflict of interest

The authors declare that they have no conflicts of interest. The authors alone are responsible for the content and writing of the paper.

References

1. Beatty J, Biggs PJ, Gall K, *et al.* A new miniature x-ray device for interstitial radiosurgery: dosimetry. *Med Phys* 1996; **23**:53-62.
2. Schneider F, Clausen S, Thölking J, *et al.* A novel approach for superficial intraoperative radiotherapy (IORT) using a 50 kV X-ray source: a technical and case report. *J Appl Clin Med Phys* 2014; **15**:4502.

3. Intrabeam System PRS 500 with XRS. User manual for the core system. Issue 3.0. Oberkochen, Germany. Carl Zeiss Medical Company; 2007.
4. Biggs DS, Thomson ES. Radiation properties of a miniature X-ray device for radiosurgery. *Br J Radiol* 1996; **69**:544-7.
5. Armoogum KS, Parry JM, Souliman SK, et al. Functional intercomparison of intraoperative radiotherapy equipment - Photon Radiosurgery System. *Radiat Oncol* 2007; **2**:11.
6. Pimpinella M, Mihailescu D, Guerra AS, Laitano RF. Dosimetric characteristics of electron beams produced by a mobile accelerator for IORT. *Phys Med Biol* 2007; **52**:6197-214.
7. Mills MD, Fajardo LC, Wilson DL, et al. Commissioning of a mobile electron accelerator for intraoperative radiotherapy. *J Appl Clin Med Phys* 2001; **2**:121-30.
8. Strigari L, Soriani A, Landoni V, et al. Radiation exposure of personnel during intraoperative radiotherapy (IORT): radiation protection aspects. *J Exp Clin Cancer Res* 2004; **23**:489-94.
9. Veronesi U, Orecchia R, Luini A, et al. Full-dose intraoperative radiotherapy with electrons during breast-conserving surgery: experience with 590 cases. *Ann Surg* 2005; **242**:101-6.
10. Beal K, McCormick B, Zelefsky MJ, et al. Single-fraction intraoperative radiotherapy for breast cancer: early cosmetic results. *Int J Radiat Oncol Biol Phys* 2007; **69**:19-24.
11. Vaidya JS, Tobias JS, Baum M, et al. Intraoperative radiotherapy for breast cancer. *Lancet Oncol* 2004; **5**:165-73.
12. Lam SCP, Xu Y, Ingram G, Chong LF. Dosimetric characteristics of INTRABEAM flat and surface applicators. *Transl Cancer Res* 2014; **3**: 106-11.
13. Park CC, Bevan A, Podgorsak MB, Pouliot J, Yom SS. Electronic Brachytherapy. Evaluation Subcommittee of ASTRO's Emerging Technology Committee; 2008.
14. European Commission in Radiation Protection 91. Criteria for Acceptability of Radiological (Including Radiotherapy) and Nuclear Medicine Installations. Luxembourg: Office for Official Publications of the European Community; ISBN 92-828-1140-9: 1997. Available from http://ec.europa.eu/energy/nuclear/radiation_protection/doc/publication/091_en.pdf