

## Analysis and Performance Evaluation of the Static and Dynamic Channel Bonding for the IEEE 802.11ac WLAN

<https://doi.org/10.3991/ijim.v17i13.41601>

Ziyad Khalaf Farej<sup>(✉)</sup>, Mohammed Ahmed Hassan

Department of Computer Techniques Engineering, Northern Technical University, Mosul, Iraq  
drziyad.farej@ntu.edu.iq

**Abstract**—According to the rising number of users and the application development that needs fast transfer rates. The main objective behind the development of IEEE 802.11ac was to deliver WLANs with exceptionally very high throughput rates. Significant improvements were incorporated into the PHY and MAC layers to achieve this, leading to enhanced data rates and overall network performance. These enhancements have enabled the standard 802.11ac to support channel bonding schemes. This paper looks at how channel bonding affects the performance of system, especially in terms of delay and amount of throughput. The research paper looks at four different scenarios with different numbers of channel BW 40,80 & 160MHz, and various spatial streams (SS) from 1 to 8. The network simulator (NS-3) version 3.37 is used to simulate these scenarios. The results of the simulation indicate that when Dynamic Channel Bonding (DCB) is applied, the highest throughput and least amount of delay values are acquired. Specifically, for MIMO (8×8) SS and with respect to the Static Channel Bonding (SCB), the best improvement of throughput and delay are obtained with DCB in the highest (48 node number) scenario. The throughput development values are (90.21%, 87.3%, and 42.91%) and the delay improvement values are (47.43%, 46.61%, and 30.03%) for channel BWs 40,80, &160 MHz, respectively.

**Keywords**—SCB, DCB, MIMO, IEEE 802.11ac, NS-3

### 1 Introduction

In recent years, wireless local area network (WLAN) has rapidly evolved into a key aspect of our daily lives. One of the most successful commercial wireless technologies, Wireless Fidelity (Wi-Fi) according to the IEEE 802.11 WLAN standard supports the rising users needs for a wide range of services[1]. Consequently, IEEE802.11 has developed from 802.11a/b/g/n to 802.11ac to provide a very high throughput (VHT) that is increasingly required [2]. The later standard supports various channel bandwidths 20MHz, 40MHz, and 80MHz, and offers a 160MHz channel with 80+80MHz non-contiguous as an additional feature [3]. WLANs standardized and commercialized the IEEE802.11 as Wi-Fi. which has a key place in the provision of wireless Internet access. Typical WLAN has an Access Point (AP) serving a set of mobile users through

wireless radio links. The recent growth in the mobile users and the advent of data-intensive mobile applications, like augmented reality and online gaming, has brought an enormous increase in mobile data traffic [4]. Therefore, wireless network standards need to develop key enabling technologies to provide the high throughput required by such resource-demanding mobile applications [5]. The 802.11 ac, which is adopted in this paper, is the 5<sup>th</sup> generation in Wi-Fi standards of networking that can provide up to several Gigabytes at 5 GHz in comparison to predecessor 802.11n, supporting denser modulation, such as 256-QAM (Quadrature Amplitude Modulation), faster MIMO, up to eight spatial streams (SS) and data rates of 6.9 Gbps [2, 4, 6, 7]. To enhance throughput, it employs frame aggregation to diminish protocol overhead by collecting multiple MAC protocol Data Units (MPDUs) into a single A-MPDU [8].

Channel bonding (CB), which is considered in this research paper, is included in the IEEE802.11 standards. Channel bonding (CB) was used first in the 802.11n standard [9] By grouping two adjacent non-overlapping 20 MHz fundamental channels, 802.11n users can be able to send packets of data over a 40MHz channel. Then, the IEEE802.11ac standard [3] extends channel bonding by grouping four and eight fundamental channels to use the 80MHz and 160MHz respectively. IEEE802.11ac considers channel bonding to improve wireless local area network (WLAN) performance [2]. Channel bonding is an important technique for improving data rates by increasing the highest data rate in accordance with the channel bandwidth. The maximum linked channel width in Wi-Fi has expanded from 40MHz to 160MHz in 802.11ac/ax, but the basic channel width remains 20MHz [10]. and 320 MHz in 802.11be [11]. To employ those broader channels efficiently, IEEE 802.11ac defines double channel access protocols: static channel bonding (SCB) and dynamic channel bonding (DCB) [12, 13].

In this research paper, the performance of the IEEE 802.11ac is analyzed and investigated by using the NS-3 modeler for SCB and DCB.

## **2 Related work**

Many researchers have considered channel bonding and the problems associated with it, as well as its effect on WLAN performance. The authors in [14], analyzed the performance of 802.11ac standard networks with channel bonding (CB), spatial diversity, and frame aggregation (FA) (both A-MSDU and A-MPDU). The results show that 802.11ac with an 80 MHz channel configuration for single and two spatial streams outperforms 802.11n with 40 MHz configuration for double spatial streams and the highest throughput values are 28% and 84% respectively. For small frame sizes and one user, the authors in [15], show that the performance of IEEE802.11ac standard is low when channel bonding is applied because the new adjustment specifies a longer overhead than IEEE802.11a standard. the transmission period of this overhead is independent of channel width and has a major impact on the wide channels performance. To solve this issue, a new architecture of analogous transferences through primary & secondary channels is suggested. This technique aims to make the perfect use wide channels. In [16], the authors calculated network work using non-overlapping and overlapping

channels of varying widths in various deployment scenarios. According to their research, a spectrum consisting of non-overlapping channels provides the maximum throughput performance. In [13], the authors explained that the user link various available channels better than using a fixed number of channels, as the simulation results showed that dynamic channel bonding (DCB) achieves a higher data rate (throughput) than static channel bonding (SCB) by 85% for clear channel assessment (CCA). The authors of reference [17], used the analytical model to analyze and evaluate the system performance with various parameters, like the number of linked channels, the level of interference from other wireless networks, and the location of the primary channel. Their result showed that channel bonding improves network performance at low levels of external interference. The DBCA scheme is superior to the SBCA scheme in performance. In [18], the authors analyzed throughput performance and showed that the DCB under the Channel Access scheme can achieve higher throughput with fewer overlapping channels between networks. In comparison with Greedy scheme, their proposed algorithm shows in terms of throughput, a gain value of 45.65 %. The authors of reference [19], developed an analytical model to study the DCB performance in IEEE802.11ac, and the results showed that the DCB can increase data rates (throughput) even when legacy users are present. Also, based on their analysis, they developed an algorithm for multichannel users to choose the perfect primary channel for obtaining the highest throughput. In [20], the authors analyzed the throughput performance using channel bonding with and without frame aggregation. Their simulation results showed that channel bonding performs better without frame aggregation. Also, the results show that as the distance increases and in MCS 7, with channel bonding, the throughput reaches 116.44Mbps compared to 110.60Mbps when aggregation is applied with channel bonding. In [21], for dense networks, the authors proposed an analytical framework model for the channel bonding mechanism as a function of PHY layer and MAC layer parameters. The channel bonding algorithm is described, considering co-channel overlapping. Based on ns-3 simulation the obtained results show that in modulation and coding scheme of 8 levels (MCS 8), their proposed algorithm outperforms the standard threshold (with clear channel assessment -72 dB) in terms of throughput by 74%. In reference [22], the authors designed a new receiver (with additional features at PHY layer) that can eliminate interference from adjacent channels caused by previous IEEE802.11 a/n signals from workstations within the 80 MHz or 160 MHz available channels. Three channel access methods are considered. Their results show the lowest throughput for 80 MHz static channel, due to the high transmitted data in the non-primary channels which results lower chance to use or engage the entire 80 MHz channel. They also show that DCB is better than SCB and the reason for that is in DCB the IEEE 802.11ac stations are allowed to send data even when only some of the 20MHz channels are out of work.

The rest of this research paper is structured as follows: the 3<sup>rd</sup> section deals with method and material, (including 802.11ac features, channel bonding, theoretical performance and network scenarios with parameters), then the efficiency of SCB and DCB schemes for throughput and delay are compared in section 4. Lastly, the concluded part is presented in section 5.

### 3 Research methodology and material

#### 3.1 IEEE 802.11ac main features and MIMO techniques

Channel bonding is a feature of the current IEEE 802.11 ac standard that allows very high throughput (VHT) WLANs to have faster data rates. In fact, by grouping 2, 4, or 8 basic 20 MHz narrow channels to transmit data through a (40MHz, 80MHz, or 160MHz) wide channel, this method can increase the data transference percentage by 2.0769, 4.5, or 9 times, depending on the number of channels linked [12]. The PHY layer offers four key improvements: 256-QAM, Downlink Multiuser-Multiple Input Multiple Output (DL-MIMO), up to eight antennas, and support four channel bandwidths of (20MHz, 40MHz, 80MHz, and 160MHz) [23]. IEEE802.11ac uses MIMO with (OFDM) to enhance channel capacity and permits transmission data rates (throughput) of up to 780 Mbps for 1×1 Spatial Stream (SS) and 6240 Mbps for 8×8 SS [24, 25].

Three MIMO techniques are adopted in the IEEE 802.11 standards to enhance the wireless network performance. They are (a): Spatial-Division-Multiplexing (SDM), which is used in this research; (b): Space-Time-Block-Coding (STBC); and (c): Low-Density-Parity-Check (LDPC) channel coding [26, 27]. The MAC layer uses frame aggregation, which entails stringing together multiple data packets from top layer into a single big data frame. The overhead of transmitting multiple frames is decreased due to the elimination of the header overhead and the inter-frame time. The frame aggregation mechanism of the standard 802.11ac MAC layer is explained by [28, 29]. Frame aggregation in 802.11ac has two levels as illustrated in Figure 1(a) The second level physical service dataUnit (PSDU) can be up to 1048575 bytes. The MAC layer also includes block acknowledgment (BA). The receiver sends a block acknowledgment to confirm that it has received every frame. Frames can be sent without requiring acknowledgment of every received unicast frame, as seen in Figure 1(b). This makes it ideal for time-sensitive unicast apps or applications that support real-time (such as video streaming or audio) that require retransmission [8, 30, 31].

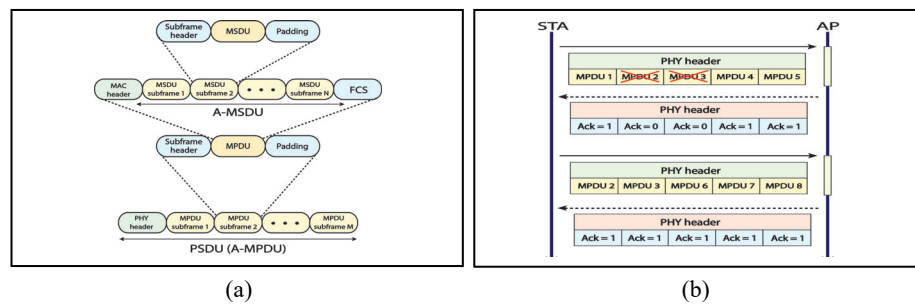

**Fig. 1.** Shows (a): Two-levels of frame aggregation (FA), and (b): Aggregation with block acknowledgment

### 3.2 Channel bonding

WLANs can use multiple non-overlapping channels in one transmission with 802.11ac. As illustrated in Figure 2, two neighboring 20MHz channels could be combined to make a 40MHz channel, and two nearby 40MHz channels could be combined to form an 80MHz channel. Two contiguous or non-contiguous 80 MHz channels can generate a 160MHz channel. A 20 MHz channel is referred to as a primary (or basic) channel. Each user employs fields of controlling in the beacon to specify its bandwidth and primary channel selection to support this increased channelization [4, 12].

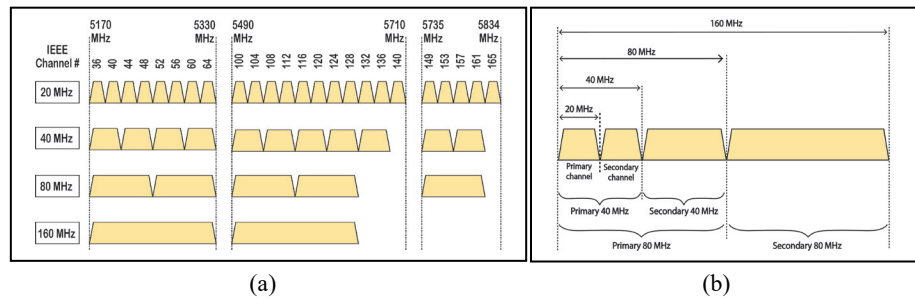

Fig. 2. Shows (a). 802.11ac channel allocation in the 5 GHz Band, and (b). Association between primary and secondary subchannels

Channel bonding creates a larger bandwidth channel by merging a primary channel with one or more non-primary channels. The basic distributed coordination function (DCF) is used by all network users to vie for channel occupancies just on the primary channel [12]. When a user needs to send packets, it first detects its primary channel. After sensing the primary channel idle for a DCF inter-frame space (DIFS) length, the user initiates the back-off process by choosing a random number for the back-off counter. Once the node detects the primary channel is idle, it begins a linear decrease in the back-off timer. Back-off timers are stopped, and the remaining time is recorded if the primary channel is detected to be busy through the back-off process. When the primary channel is detected as idle for a DIFS duration, the back-off procedure is restarted with the recorded remaining duration. The user must sense its secondary channels for a point coordination function (PCF) inter-frame space (PIFS) period before the timer expires. When the timer expires, the user has two options for determining which channels to transmit on: 1) Static channel bonding, as shown in Figure 3(a), the user begins conveying by employing a whole assigned channel only when all channels (primary & secondary channels) are out of work. Otherwise, it will begin a new back-off procedure.; 2) Dynamic channel bonding, as shown in Figure 3(b), even if some of the secondary channels are busy at the time of PIFS duration, the user starts transmitting employing the primary channel, and the out of work secondary channels neighboring to the primary channel without starting a new back-off procedure[12, 13].

The variation among static and dynamic channel bonding is in the bonding method used not all non-primary channels in PIFS are idle. If the user uses static channel bonding, it will stop transmitting, reselect the back-off duration, and repeat the process until

all non-primary channels are out of work. If the user employs DCB, it will link as many idle secondary channels as possible that are head-to-head to the primary channel and start transmission [13].

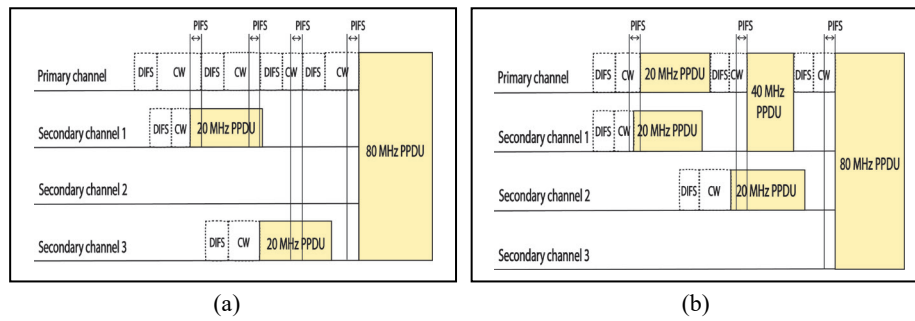

Fig. 3. Shows Channel bonding schemes (a): SCB, and (b): DCB

### 3.3 Theoretical performance of throughput and delay for IEEE802.11 ac

The simulation results are confirmed by the presented theoretical performance, which is supported by previous studies in [32-35]. The highest data rate (Throughput) and delay (latency) can be calculated as follows: (1) and (2).

$$Throughput_{(bits/sec)} = \frac{N_{DS} \times N_{SS} \times N_{Bits\ per\ symbol} \times CR}{T_{OFDM}} \quad (1)$$

$$Delay_{(second)} = \frac{Max\ A-MPDU\ Length}{Max\ DR} \quad (2)$$

$N_{DS}$  = Data subcarriers number (108, 234, and 468) for (40, 80, and 160 MHz).

$N_{SS}$  = Spital streams number is changeable (from 1 to 8).

$N_{Bits\ per\ symbol}$  = Bits per symbol number equal 8 for 256-QAM.

$CR$  = Code rate (equal 3/4).

$T_{OFDM}$  = Time of OFDM symbol (equal 3.6  $\mu$ s include GI of 400ns and provided by  $1/\Delta F$ , where  $\Delta F$  equals frequency gap between subcarriers).

Max A-MPDU: is the 2<sup>nd</sup> level of aggregation (equal 1048575 bytes).

Max DR=highest data rate (throughput).

Table 1. (a-c) Illustrate the highest theoretical data rate of the 802.11ac standard for both throughput and overall delay for different SS and channels BW

a. Channel Bandwidth 40 MHz

SS	1×1	2×2	4×4	8×8
Throughput (Mbps)	180	360	720	1440
Delay (Sec.)	0.0466	0.0233	0.01165	0.00582

b. Channel Bandwidth 80 MHz

SS	1×1	2×2	4×4	8×8
Throughput (Mbps)	390	780	1560	3120
Delay (Sec.)	0.0215	0.01075	0.00537	0.00268

c. Channel Bandwidth 160 MHz

SS	1×1	2×2	4×4	8×8
Throughput (Mbps)	780	1560	3120	6240
Delay (Sec.)	0.01075	0.00537	0.00268	0.00134

### 3.4 Modeled network scenarios

To evaluate the performance of an IEEE 802.11ac-based WLAN, Figure 4 shows four (single hop) random topology scenarios with various number of nodes (4, 8, 16, and 48). The discrete-event network simulator for networking systems (NS-3) version ns-3.37 was used to model and simulate these scenarios.

NS-3 simulations are carried out by employing the simulation parameters illustrated in Table 2.

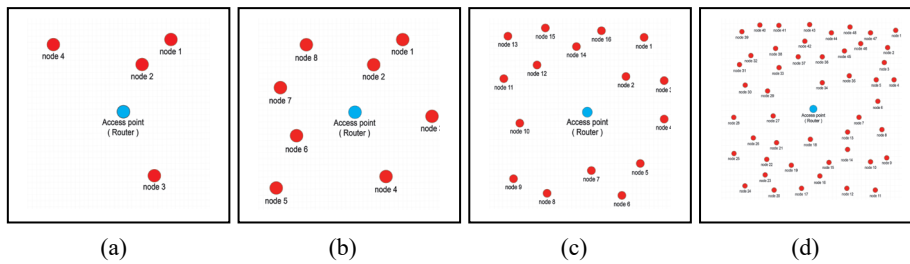

Fig. 4. (a-d) Show four simulation scenarios: (a) 4, (b) 8, (c) 16, and (d) 48 nodes

Table 2. 802.11ac WLAN simulation parameters

Parameter	Values
Physical characteristics	802.11ac, 5 GHz
Packet size (bytes)	2048
Data rate (Mbps)	1440, 3120 and 6240
Bandwidth (MHz)	40,80 and 160
A-MSDU aggregation (bytes)	11454
A-MPDU aggregation (bytes)	1048575
Transmit power (Watt)	0.1
CWmin	15
CWmax	1023
DIFS (μs)	34
SIFS (μs)	16

Parameter	Values
Slot time ( $\mu\text{s}$ )	9
AIFS ( $\mu\text{s}$ )	43 (SIFS + 3 × Slot time)
Modulation and coding scheme	(256 – QAM)
Spatial streams (SS)	1 to 8
Coding rate	3/4
Guard interval (ns)	400
Simulation time (sec)	10

## 4 The results and analysis of the NS-3 simulation

The simulation findings of the NS-3 modeler for the regarded performance metrics (throughput and delay) are illustrated in the Figures 5, 6, 7 and 8, 9, 10 respectively. Various channel bandwidths (40MHz, 80MHz, and 160MHz) and various SS or MIMO (1, 2, 4, and 8) antenna configurations for (SCB and DCB) are taken into account in the process of examining the performance of a modeled IEEE802.11ac WLAN with different numbers of users as follows:

### 4.1 Throughput

For different MIMO spatial streams (1×1, 2×2, 4×4, and 8×8), the Figures 5(a-d), 6(a-d), and 7(a-d) show the variations in throughput for channels with bandwidth 40, 80, and 160 MHz respectively. It is obvious that as the number of spatial streams increases, so does channel capacity, and thus throughput goes up. Though, the throughput drops as the number of users rises, where the explanation for this is that more packets are being sent through the bottleneck or coordinator (AP) and competition for channels between nodes, which increases the risk of packet drop and collision. The throughput performance for different channel bonding can be considered as follows:

#### a) SCB throughput performance:

- For 40 MHz channel BW, the results in Figure 5(a and d) shows that the mean value of throughput has high constant values of (147.254, 131.752, 107.532, and 48.341 Mbps) for 1×1 SS, while that for 8×8 SS are (1153, 1031.62, 841.976 and 378.51 Mbps) for 4, 8, 16 and 48 nodes number scenarios respectively.
- For 80 MHz channel BW, the results in Figure 6(a and d) shows that mean value of throughput has high constant values of (310.243, 285.624, 244.913, and 125.47 Mbps) for 1×1 SS, while that for 8×8 SS are (2429.2, 2236.44, 1917.67 and 982.45 Mbps) for 4, 8, 16 and 48 nodes number scenarios respectively.
- For 160 MHz channel BW, the results in Figure 7(a and d) shows that mean value of throughput has high constant values of (640.423, 599.843, 535.321, and 390.12 Mbps) for 1×1 SS, while that for 8×8 SS are (5014.51, 4696.77, 4191.56 and 3054.6 Mbps) for 4, 8, 16 and 48 nodes number scenarios respectively.



b) DCB throughput performance:

- When DCB is applied for 40 MHz channel BW, the throughput is improved and the highest steady-state values for 8×8 SS are (1229.23, 1139.34, 1031.55, and 719.982 Mbps) for 4, 8, 16 and 48 nodes number scenarios respectively.
- When DCB is applied for 80 MHz channel BW, the throughput is improved and the highest steady-state values for 8×8 SS are (2586.48, 2458.46, 2278.67, and 1840.16 Mbps) for 4, 8, 16 and 48 nodes number scenarios respectively.
- When DCB is applied for 160 MHz channel BW, the throughput is improved and the highest steady-state values for 8×8 SS are (5283.03, 5172.97, 4916.93, and 4365.33 Mbps) for 4, 8, 16 and 48 nodes number scenarios respectively.

In comparison with the SCB case and for all channels bandwidth (40, 80 & 160 MHz), the top enhancement in the DCB throughput values is obtained at the top (48) node numeral scenario. The reason for that is as number of nodes increases, then for SCB, the probability of acquiring (simultaneously) the main & minor channels clear decreases. As a result, the SCB throughput performance decreases and this leads to high improvement values when DCB is applied. For (1x1) and (8x8) SS the improvement values:

- For 40 MHz channel BW are (4.41%, 8.16%, 19.99%, & 86.29%) and (6.61%, 10.4%, 22.52%, & 90.21%) for nodes number of 4, 8, 16 and 48 values respectively.
- For 80 MHz channel BW are (4.28%, 7.66%, 16.37%, & 83.44%) and (6.47%, 9.93%, 18.83%, & 87.3%) for nodes number of 4, 8, 16 and 48 values respectively.
- For 160 MHz channel BW are (3.18%, 7.87%, 14.88%, & 39.96%) and (5.35%, 10.1%, 17.31%, & 42.91%) for nodes number of 4, 8, 16 and 48 values respectively.

It should be noted that the lowest improvement values are acquired at 160 MHz channel BW, this due to as the channel BW increases, then the amount of non-primary channels increases (7 secondary channel for 160 MHz) this leads to increase in the probability of acquiring more than one channel clear at the same time for SCB and as a result increase in the throughput performance and less improvement values when compared with DCB.

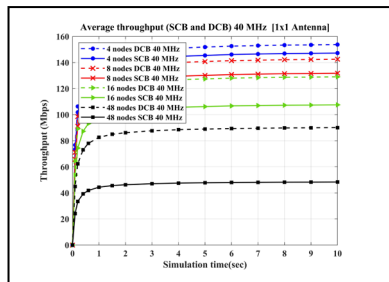

(a)

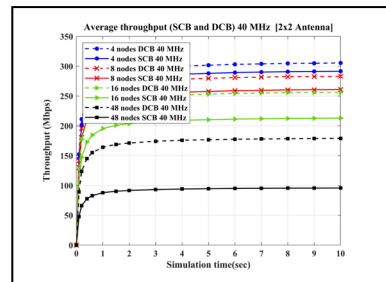

(b)

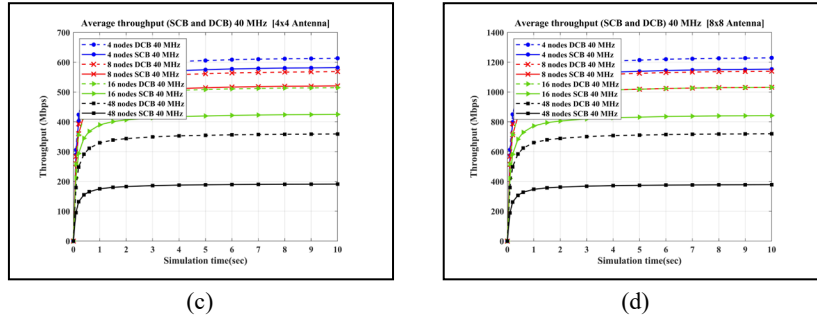

Fig. 5. (a-d) Illustrates average throughput of SCB and DCB for 40 MHz channel BW: a) 1x1 SS, b) 2x2 SS, c) 4x4 SS, and d) 8x8 SS antenna system

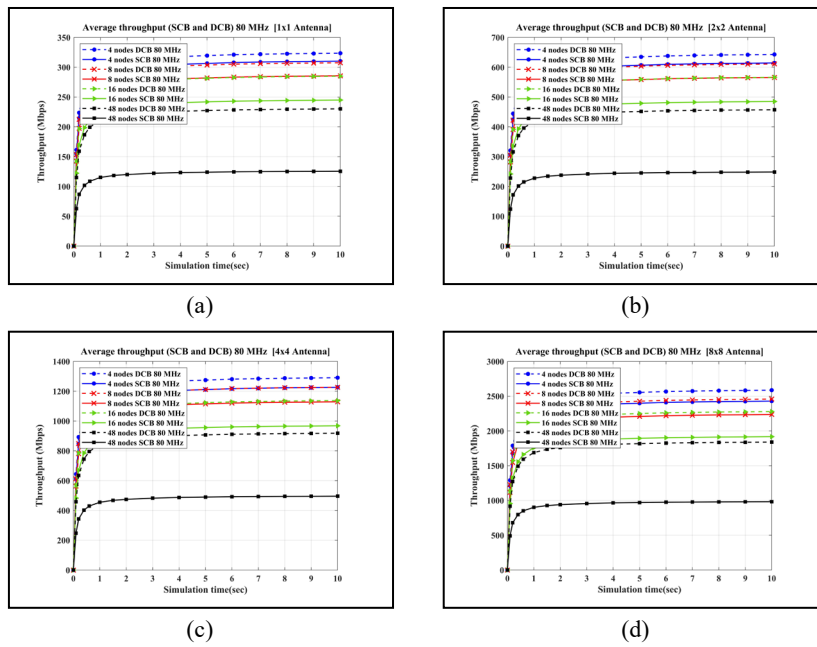
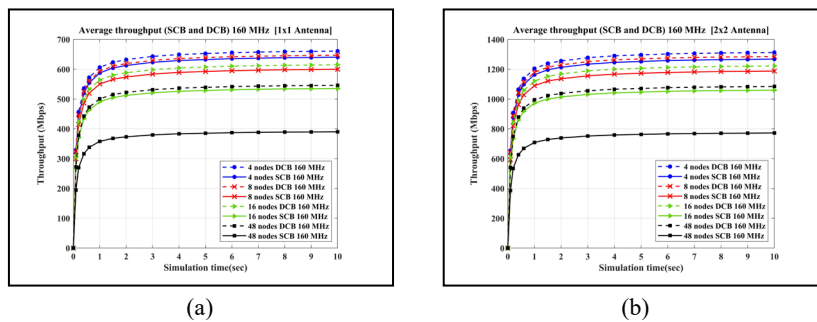

Fig. 6. (a-d) Shows average throughput of SCB and DCB for 80 MHz channel BW: a) 1x1 SS, b) 2x2 SS, c) 4x4 SS, and d) 8x8 SS antenna system



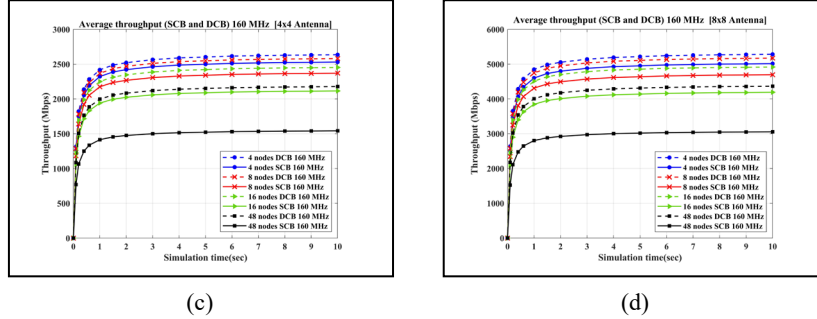

Fig. 7. (a-d) Shows average throughput of SCB and DCB for 160 MHz channel BW: a) 1x1 SS, b) 2x2 SS, c) 4x4 SS, and d) 8x8 SS antenna system

For various spatial stream and node number scenarios, tables 3,4, and 5 summarize the throughput and its improvement values for channels bandwidth 40, 80, and 160 MHz respectively. The tables show that when the spatial streams increases (and for any certain numbers of node topology), there are few percentage increases in the enhancement values, which are related to spatial stream interaction and are more probably a constraint of the protocol at the layer of Medium Access Control (MAC).

Table 3. Summarizing data rate (throughput) values (in Mbps) for channel bandwidth 40 MHz

SS	4 Nodes			8 Nodes			16 Nodes			48 Nodes		
	SCB	DCB	Improve %	SCB	DCB	Improve %	SCB	DCB	Improve %	SCB	DCB	Improve %
1x1	147.254	153.75	4.41	131.752	142.506	8.16	107.532	129.024	19.99	48.341	90.054	86.29
2x2	291.563	305.44	4.76	260.869	283.102	8.52	212.913	256.319	20.39	95.715	178.901	86.91
4x4	581.948	613.309	5.39	520.684	568.456	9.17	424.966	514.677	21.11	191.04	359.225	88.03
8x8	1153	1229.23	6.61	1031.62	1139.34	10.4	841.976	1031.55	22.52	378.51	719.982	90.21

Table 4. Summarizing the throughput values (in Mbps) for channel bandwidth 80 MHz

SS	4 Nodes			8 Nodes			16 Nodes			48 Nodes		
	SCB	DCB	Improve %	SCB	DCB	Improve %	SCB	DCB	Improve %	SCB	DCB	Improve %
1x1	310.243	323.513	4.28	285.624	307.5	7.66	244.913	285.012	16.37	125.47	230.164	83.44
2x2	614.281	642.691	4.62	565.536	610.879	8.02	484.928	566.205	16.76	248.43	457.244	84.05
4x4	1226.08	1290.49	5.25	1128.79	1226.62	8.67	967.896	1136.91	17.46	495.87	918.124	85.16
8x8	2429.2	2586.48	6.47	2236.44	2458.46	9.93	1917.67	2278.67	18.83	982.45	1840.16	87.3

**Table 5.** Summarizing the throughput values (in Mbps) for channel bandwidth 160 MHz

SS	4 Nodes			8 Nodes			16 Nodes			48 Nodes		
	SCB	DCB	Improve %	SCB	DCB	Improve %	SCB	DCB	Improve %	SCB	DCB	Improve %
1×1	640.423	660.792	3.18	599.843	647.026	7.87	535.321	615	14.88	390.12	546.008	39.96
2×2	1268.04	1312.73	3.52	1187.69	1285.38	8.23	1059.94	1221.76	15.27	772.44	1084.7	40.43
4×4	2530.95	2635.9	4.15	2370.58	2580.99	8.88	2115.59	2453.24	15.96	1541.8	2178.03	41.27
8×8	5014.51	5283.03	5.35	4696.77	5172.97	10.1	4191.56	4916.93	17.31	3054.6	4365.33	42.91

## 4.2 Delay

For different MIMO (1×1, 2×2, 4×4, and 8×8) spatial streams, Figures 8(a-d), 9(a-d), and 10(a-d) show the variations in delay for channels with bandwidth 40, 80, and 160 MHz respectively. It is obvious as spatial streams grow, channel capacity and throughput increase, and thus delay decreases. Nonetheless, the delay rises as the users rise, and the explanation for this is that more packets are being sent through the coordinator (AP) and competition among nodes for channels access leads to step up the risk of packet drop and collision. The delay performance for different channel bonding can be considered as follows:

### a) SCB delay performance:

- For 40 MHz channel BW, the results in Figure 8(a and d) shows that the highest steady-state values for the average delay of (0.05697, 0.06367, 0.07801, and 0.1735 sec) for 1×1 SS, while that for 8×8 SS are (0.00728, 0.00813, 0.00996 and 0.0222 sec) for 4, 8, 16 and 48 nodes number scenarios respectively.
- For 80 MHz channel BW, the results in Figure 9(a and d) shows that the highest steady-state values for the average delay of (0.02704, 0.02937, 0.03425, and 0.0669 sec) for 1×1 SS, while that for 8×8 SS are (0.00345, 0.00375, 0.00437 and 0.0085 sec) for 4, 8, 16 and 48 nodes number scenarios respectively.
- For 160 MHz channel BW, the results in Figure 10(a and d) shows that the highest steady-state values for the average delay of (0.0131, 0.01398, 0.01567, and 0.0215 sec) for 1×1 SS, while that for 8×8 SS are (0.00167, 0.00179, 0.002 and 0.0027 sec) for 4, 8, 16 and 48 nodes number scenarios respectively.

### b) DCB delay performance:

When DCB is applied, the delay values are improved (i.e. reduced) and the lowest steady-state values are obtained for 8×8 SS. These values, for 40 MHz channel BW are (0.00682, 0.00736, 0.00813, and 0.01165 sec), for 80 MHz channel BW are (0.00324, 0.00341, 0.00368, and 0.00456 sec), for 160 MHz channel BW are (0.00159, 0.00162, 0.00171, and 0.00192 sec) for 4, 8, 16 and 48 nodes number scenarios in respect.

Compared the SCB case and for all channels bandwidth (40, 80 & 160 MHz), the perfect improvement in the DCB delay values is achieved at the top (48) node number scenario. The reason for that is again as the nodes grow, then for SCB, the probability of obtaining the primary & secondary channels clear at the same time is decreased, as

a result, the SCB delay performance tends to be worse (i.e. longer delay) and this leads to high improvement values when DCB is applied.

For (1x1) and (8x8) SS, the improvement values are as follows:

When channel BW is 40 MHz, these values are (4.23 %, 7.55 %, 16.66 %, and 46.32 %) and (6.2 %, 9.45 %, 18.38 %, and 47.43 %), when channel BW is 80 MHz, they are (4.1 %, 7.11 %, 14.07 %, and 45.49 %) and (6.08 %, 9.03 %, 15.84 %, and 46.61 %), when channel BW is 160 MHz, they are (3.08 %, 7.29 %, 12.96 %, and 28.55 %) and (5.08 %, 9.21 %, 14.75 %, and 30.03 %) for 4, 8, 16 and 48 nodes number scenarios respectively.

It should be noted again that the lowest improvement values are acquired at 160 MHz channel BW, this due to the fact that as the channel BW increases, then the number of non-primary channels increases (7 secondary channel for 160 MHz) and again this leads to increase in the probability of acquiring more than one channel clear at the same time for SCB and as a result worse delay performance (i.e. longer delay time) and less improvement values when compared with DCB.

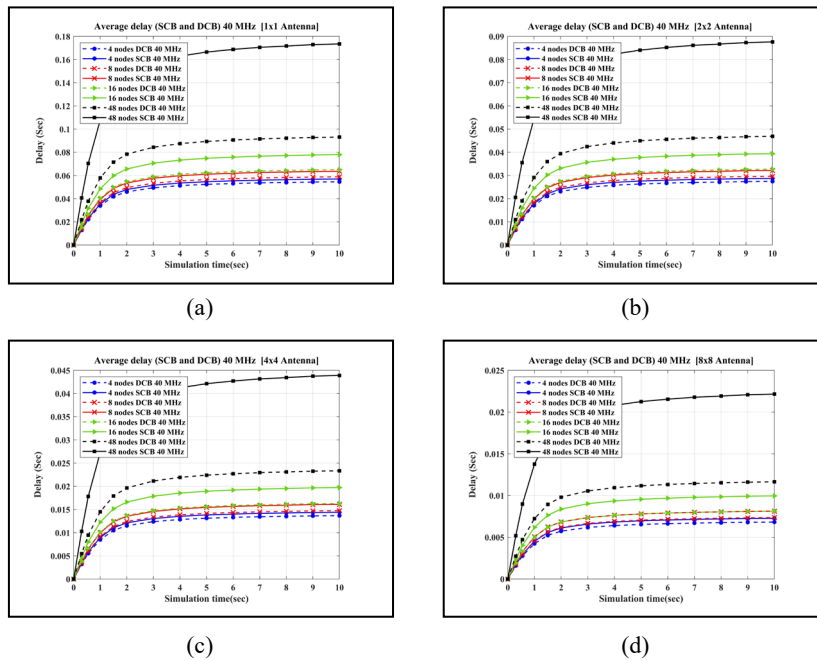

Fig. 8. (a-d) Shows average delay of SCB and DCB for 40 MHz channel BW: a) 1x1 SS, b) 2x2 SS, c) 4x4 SS, and d) 8x8 SS antenna system

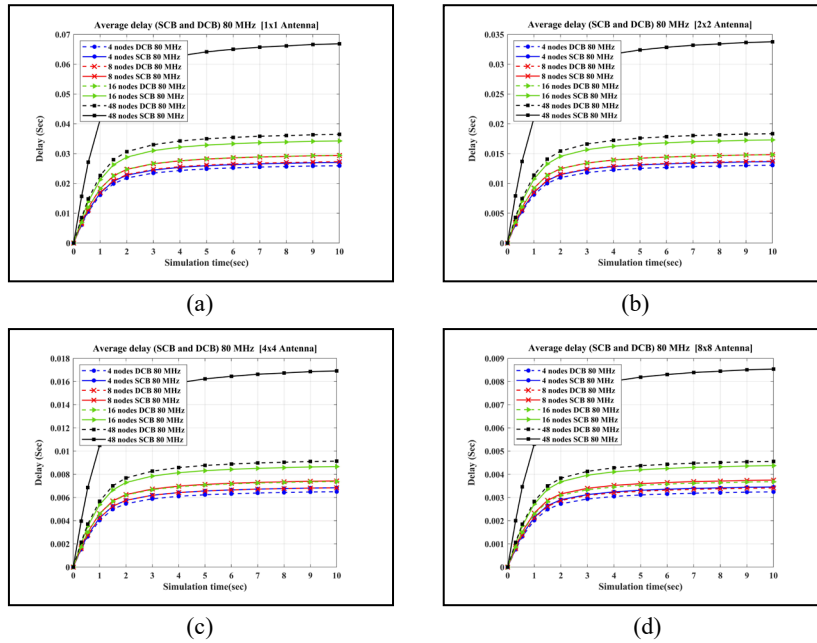

Fig. 9. (a - d) Shows average delay of SCB and DCB for 80 MHz channel BW: a)1x1 SS, b) 2x2 SS, c) 4x4 SS, and d) 8x8 SS antenna system

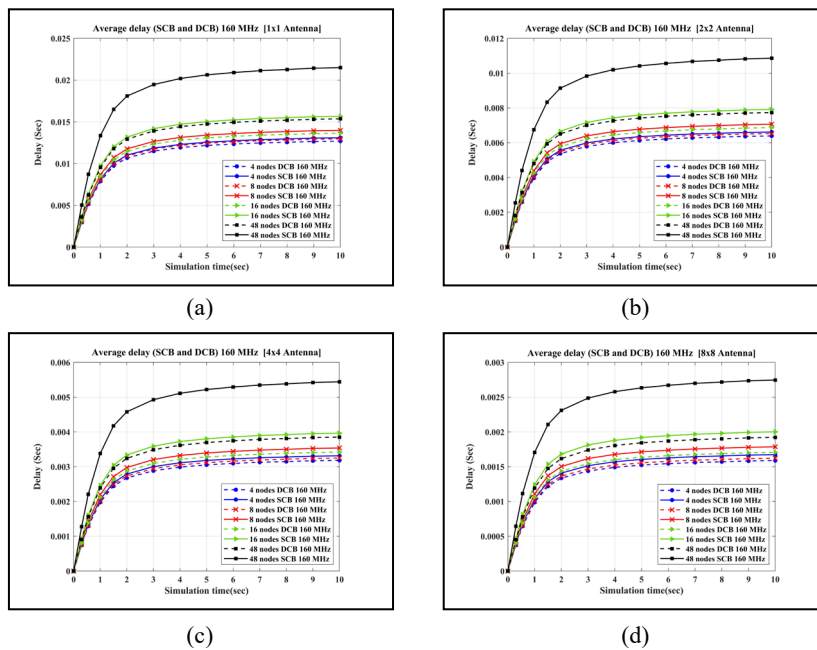

Fig. 10.(a-d) Shows average delay of SCB and DCB for 160 MHz channel BW: a)1x1 SS, b) 2x2 SS, c) 4x4 SS, and d) 8x8 SS antenna system

Tables 6,7, and 8 summarize the delay performance and its improvement (in DCB with respect to SCB) values for channels bandwidth 40, 80, and 160 MHz respectively.

**Table 6.** Summarizing the delay values (in Sec) for channel bandwidth 40 MHz

SS	4 Nodes			8 Nodes			16 Nodes			48 Nodes		
	SCB	DCB	Imp-rove %	SCB	DCB	Imp-rove %	SCB	DCB	Imp-rove %	SCB	DCB	Imp-rove %
1×1	0.05697	0.05456	4.23	0.06367	0.05886	7.55	0.07801	0.06502	16.66	0.1735	0.09315	46.32
2×2	0.02877	0.02746	4.54	0.03216	0.02963	7.85	0.0394	0.03273	16.93	0.0876	0.04689	46.5
4×4	0.01441	0.01368	5.11	0.01611	0.01476	8.4	0.01974	0.0163	17.43	0.0439	0.02335	46.82
8×8	0.00728	0.00682	6.2	0.00813	0.00736	9.45	0.00996	0.00813	18.38	0.0222	0.01165	47.43

**Table 7.** Summarizing the delay values (in Sec) for channel bandwidth 80 MHz

SS	4 Nodes			8 Nodes			16 Nodes			48 Nodes		
	SCB	DCB	Imp-rove %	SCB	DCB	Imp-rove %	SCB	DCB	Imp-rove %	SCB	DCB	Imp-rove %
1×1	0.02704	0.02593	4.1	0.02937	0.02728	7.11	0.03425	0.02943	14.07	0.0669	0.03645	45.49
2×2	0.01366	0.01305	4.42	0.01483	0.01373	7.42	0.0173	0.01482	14.35	0.0338	0.01835	45.67
4×4	0.00684	0.0065	4.99	0.00743	0.00684	7.98	0.00867	0.00738	14.87	0.0169	0.00914	45.99
8×8	0.00345	0.00324	6.08	0.00375	0.00341	9.03	0.00437	0.00368	15.84	0.0085	0.00456	46.61

**Table 8.** Summarizing delay values (in Sec) for channel bandwidth 160 MHz

SS	4 Nodes			8 Nodes			16 Nodes			48 Nodes		
	SCB	DCB	Imp-rove %	SCB	DCB	Imp-rove %	SCB	DCB	Imp-rove %	SCB	DCB	Imp-rove %
1×1	0.0131	0.01269	3.08	0.01398	0.01296	7.29	0.01567	0.01364	12.96	0.0215	0.01536	28.55
2×2	0.00662	0.00639	3.4	0.00706	0.00653	7.6	0.00791	0.00687	13.25	0.0109	0.00773	28.79
4×4	0.00331	0.00318	3.98	0.00354	0.00325	8.15	0.00397	0.00342	13.76	0.0054	0.00385	29.21
8×8	0.00167	0.00159	5.08	0.00179	0.00162	9.21	0.002	0.00171	14.75	0.0027	0.00192	30.03

## 5 Conclusions

In this research paper, different (4, 8, 16, and 48) node number scenarios are proposed to simulate WLANs in line with the standard of IEEE 802.11ac. The simulation software (NS-3 v3.37) is used to analyze and investigate the performance efficiency of IEEE 802.11ac-based WLANs for different SCB and DCB. For these scenarios, extensive simulation processes are carried out to improve network performance. The simulation outcomes reveal that when Dynamic Channel Bonding (DCB) is applied the highest throughput and the least amount of delay are satisfied. In comparison with SCB, the DCB achieved the best improvement values for the highest (48) nodes number scenario

when 8×8 SS is used. These values (for throughput and delay) are (90.21%, 87.3%, & 42.91%) and (47.43%, 46.61%, & 30.03%) for 40, 80, & 160 MHz channel BW respectively. These optimization values reflect the standard efficiency of dynamic channel bonding at the PHY layer and also demonstrate the standard feasibility of operating in high-density environments networks.

## 6 References

- [1] U. Cisco, "Cisco annual internet report (2018–2023) white paper," Cisco: San Jose, CA, USA, vol. 10, no. 1, pp. 1–35, 2020.
- [2] R. Karmakar, S. Chattopadhyay, and S. Chakraborty, "Impact of IEEE 802.11 n/ac PHY/MAC high throughput enhancements on transport and application protocols—A survey," *IEEE Communications Surveys & Tutorials*, vol. 19, no. 4, pp. 2050–2091, 2017. <https://doi.org/10.1109/COMST.2017.2745052>
- [3] M. S. Gast, *802.11 ac: a survival guide: Wi-Fi at gigabit and beyond*. "O'Reilly Media, Inc.," 2013.
- [4] O. Bejarano, E. W. Knightly, and M. Park, "IEEE 802.11 ac: from channelization to multi-user MIMO," *IEEE Communications Magazine*, vol. 51, no. 10, pp. 84–90, 2013. <https://doi.org/10.1109/MCOM.2013.6619570>
- [5] J. Cha, H. Jin, B. C. Jung, and D. K. Sung, "Performance comparison of downlink user multiplexing schemes in IEEE 802.11 ac: Multi-user MIMO vs. frame aggregation," in *2012 IEEE Wireless Communications and Networking Conference (WCNC)*, 2012, pp. 1514–1519. <https://doi.org/10.1109/WCNC.2012.6214021>
- [6] B. S. Kim, H. Y. Hwang, and D. K. Sung, "Effect of frame aggregation on the throughput performance of IEEE 802.11 n," in *2008 IEEE Wireless Communications and Networking Conference*, 2008, pp. 1740–1744. <https://doi.org/10.1109/WCNC.2008.310>
- [7] Z. K. Farej and M. M. Jasim, "Investigation on the performance of the IEEE 802.11n based wireless networks for multimedia services," in *2018 2nd International Conference for Engineering, Technology and Sciences of Al-Kitab (ICETS)*, 2018, pp. 48–53. <https://doi.org/10.1109/ICETS.2018.8724626>
- [8] N. Khalil and A. Najid, "Performance analysis of 802.11 ac with frame aggregation using NS3," *International Journal of Electrical and Computer Engineering*, vol. 10, no. 5, p. 5368, 2020. <https://doi.org/10.11591/ijece.v10i5.pp5368-5376>
- [9] M. Gast, *802.11 n: a survival guide*. "O'Reilly Media, Inc.," 2012.
- [10] E. Khorov, A. Kiryanov, A. Lyakhov, and G. Bianchi, "A tutorial on IEEE 802.11 ax high efficiency WLANs," *IEEE Communications Surveys & Tutorials*, vol. 21, no. 1, pp. 197–216, 2018. <https://doi.org/10.1109/COMST.2018.2871099>
- [11] E. Khorov, I. Levitsky, and I. F. Akyildiz, "Current status and directions of IEEE 802.11 be, the future Wi-Fi 7," *IEEE access*, vol. 8, pp. 88664–88688, 2020. <https://doi.org/10.1109/ACCESS.2020.2993448>
- [12] I. S. Association, "IEEE Computer Society:" Part 11: Wireless LAN Medium Access Control (MAC) and Physical Layer (PHY) Specifications; Amendment 4: Enhancements for Very High Throughput for Operation in Bands Below 6 GHz", *IEEE Std 802.11 acTM*, The Institute of Electrical and." Inc, 2013.
- [13] M. Park, "IEEE 802.11 ac: Dynamic bandwidth channel access," in *2011 IEEE international conference on communications (ICC)*, 2011, pp. 1–5. <https://doi.org/10.1109/icc.2011.5963089>



- [14] E. H. Ong, J. Knecht, O. Alanen, Z. Chang, T. Huovinen, and T. Nihtilä, "IEEE 802.11 ac: Enhancements for very high throughput WLANs," in 2011 IEEE 22nd International Symposium on Personal, Indoor and Mobile Radio Communications, 2011, pp. 849–853.
- [15] J. Fang and I. Lu, "Efficient channel access scheme for multiuser parallel transmission under channel bonding in IEEE 802.11 ac," IET Communications, vol. 9, no. 13, pp. 1591–1597, 2015. <https://doi.org/10.1049/iet-com.2014.1223>
- [16] B. Bellalta, A. Checco, A. Zocca, and J. Barcelo, "On the interactions between multiple overlapping WLANs using channel bonding," IEEE Transactions on Vehicular Technology, vol. 65, no. 2, pp. 796–812, 2015. <https://doi.org/10.1109/TVT.2015.2400932>
- [17] B. Bellalta, A. Faridi, J. Barcelo, A. Checco, and P. Chatzimisios, "Channel bonding in short-range WLANs," in European Wireless 2014; 20th European Wireless Conference, 2014, pp. 1–7.
- [18] C. Kai, Y. Liang, T. Huang, and X. Chen, "To bond or not to bond: An optimal channel allocation algorithm for flexible dynamic channel bonding in WLANs," in 2017 IEEE 86th Vehicular Technology Conference (VTC-Fall), 2017, pp. 1–6. <https://doi.org/10.1109/VTCFall.2017.8288188>
- [19] S. Khairy, M. Han, L. X. Cai, Y. Cheng, and Z. Han, "A renewal theory based analytical model for multi-channel random access in IEEE 802.11 ac/ax," IEEE Transactions on Mobile Computing, vol. 18, no. 5, pp. 1000–1013, 2018. <https://doi.org/10.1109/TMC.2018.2857799>
- [20] A. Bhalavi, S. Tokekar, and A. Saxena, "The Assessment of Channel Bonding and Aggregation on WLANs," Turkish Journal of Computer and Mathematics Education (TURCOMAT), vol. 12, no. 14, pp. 5544–5554, 2021. <https://doi.org/10.17762/turcomat.v12i3.459>
- [21] L. Lanante and S. Roy, "Analysis and optimization of channel bonding in dense IEEE 802.11 WLANs," IEEE Transactions on Wireless Communications, vol. 20, no. 3, pp. 2150–2160, 2020. <https://doi.org/10.1109/TWC.2020.3041956>
- [22] A. Stelter, P. Szulakiewicz, R. Kotrys, M. Krasicki, and P. Remlein, "Dynamic 20/40/60/80 MHz Channel Access for 80 MHz IEEE 802.11 ac," Wireless personal communications, vol. 79, pp. 235–248, 2014. <https://doi.org/10.1007/s11277-014-1851-7>
- [23] E. Charfi, L. Chaari, and L. Kamoun, "PHY/MAC enhancements and QoS mechanisms for very high throughput WLANs: A survey," IEEE Communications Surveys & Tutorials, vol. 15, no. 4, pp. 1714–1735, 2013. <https://doi.org/10.1109/SURV.2013.013013.00084>
- [24] A. T. Al-Heety, M. T. Islam, A. H. Rashid, H. N. A. Ali, A. M. Fadil, and F. Arabian, "Performance Evaluation of Wireless data traffic in Mm wave massive MIMO communication," Indones. J. Electr. Eng. Comput. Sci, vol. 20, no. 3, 2020. <https://doi.org/10.11591/ijeecs.v20.i3.pp1342-1350>
- [25] G. Z. Khan, R. Gonzalez, E.-C. Park, and X.-W. Wu, "Analysis of very high throughput (VHT) at MAC and PHY layers under MIMO channel in IEEE 802.11 ac WLAN," in 2017 19th International Conference on Advanced Communication Technology (ICACT), 2017, pp. 877–888. <https://doi.org/10.23919/ICACT.2017.7890239>
- [26] S. R. Chaudhary, A. J. Patil, and A. V. Yadao, "WLAN-IEEE 802.11 ac: Simulation and performance evaluation with MIMO-OFDM," in 2016 Conference on Advances in Signal Processing (CASP), 2016, pp. 440–445. <https://doi.org/10.1109/CASP.2016.7746211>
- [27] E. Ghayoula, M. H. Taieb, J.-Y. Chouinard, R. Ghayoula, and A. Bouallegue, "Improving MIMO systems performances by concatenating LDPC decoder to the STBC and MRC receivers," in 2015 world symposium on computer networks and information security (Wscnis), 2015, pp. 1–6. <https://doi.org/10.1109/WSCNIS.2015.7368281>

- [28] O. Sharon and Y. Alpert, "A new aggregation based scheduling method for rapidly changing IEEE 802.11 ac wireless channels," arXiv preprint arXiv:1803.10170, 2018.
- [29] A. U. Syed and L. Trajković, "Improving VHT MU-MIMO communications by concatenating long data streams in consecutive groups," in 2015 IEEE Wireless Communications and Networking Conference Workshops (WCNCW), 2015, pp. 107–112. <https://doi.org/10.1109/WCNCW.2015.7122538>
- [30] J. Govindarajan and C. Mohanapriya, "Study on real-time media congestion avoidance technique for video streaming over wireless local area network," Indonesian Journal of Electrical Engineering and Computer Science, vol. 15, no. 3, pp. 1535–1543, 2019. <https://doi.org/10.11591/ijeecs.v15.i3.pp1535-1543>
- [31] N. S. Ravindranath, I. Singh, A. Prasad, and V. S. Rao, "Performance Evaluation of IEEE 802.11 ac and 802.11 n using NS3," Indian Journal of Science and Technology, vol. 9, no. 26, pp. 1–8, 2016. <https://doi.org/10.17485/ijst/2016/v9i26/93565>
- [32] H. T. Hazim, "Secure Chaos of 5G Wireless Communication System Based on IOT Applications," International Journal of Online & Biomedical Engineering, vol. 18, no. 12, 2022. <https://doi.org/10.3991/ijoe.v18i12.33817>
- [33] S. M. Hussain, K. M. Yusof, S. A. Hussain, R. Asuncion, and S. Ghouse, "Integration of 4G LTE and DSRC (IEEE 802.11 p) for Enhancing Vehicular Network Performance in IoV Using Optimal Cluster-Based Data Forwarding (OCDF) Protocol," International Journal of Interactive Mobile Technologies, vol. 15, no. 14, 2021. <https://doi.org/10.3991/ijim.v15i14.19201>
- [34] D. Ursutiu, M. Ghercioiu, C. Samoila, and P. Cotfas, "Wi-Fi Tags for the Remote and Virtual Laboratory," International Journal of Interactive Mobile Technologies, vol. 2, no. 2, 2008.
- [35] Z. K. Farej and O. M. Ali, "On the evaluation of the IEEE 802.11ac WLAN performance with QoS deployment," Indonesian Journal of Electrical Engineering and Computer Science, vol. 24, no. 3, pp. 1618–1627, 2021. <https://doi.org/10.11591/ijeecs.v24.i3.pp1618-1627>

## 7 Authors

**Dr. Ziyad Khalaf Farej** is an Asst. Prof. and has BSc. in Electronic System Eng. from Cranfield University/UK with honor degree in 1989. MSc. in Spread Spectrum System/FH from Mosul University in 2003. Ph.D. in Computer and Communication Networks (Mesh Network based WIMAX IEEE 802.16 Standard technology) from Mosul University in 2012 with excellent grade. He has been to Salford Greater Manchester University/UK in Research Scholarship for 6 months during his Ph.D. studying period (email: drziyad.farej@ntu.edu.iq).

**Mohammed Ahmed Hassan** is presently an M.Sc. student at Northern Technical University/Technical Engineering College of Mosul/Department of Computer Techniques Engineering. He received his B.Sc. degree in Computer Engineering in 2018 at Al Qalam University College, Kirkuk, Iraq (email: mohammed.ahmed@ntu.edu.iq).

Article submitted 2023-04-22. Resubmitted 2023-05-23. Final acceptance 2023-05-24. Final version published as submitted by the authors.