

NOMOGRAPHS AND FEASIBILITY GRAPHS FOR ENUMERATION OF RAVIGNEAUX-TYPE AUTOMATIC TRANSMISSIONS

Essam L. Esmail

Lecturer

College of Engineering/University of Qadisyah

Email:dr.essamesmail@yahoo.com

ABSTRACT

An automatic transmission is a device that connects an engine to the drive wheels. It keeps the engine within a certain angular velocity. Although there are many epicyclic-type automatic transmissions in production, the related configuration design methods are still tedious and borne to human error. A simple methodology needs to be developed. Therefore, the purpose of this research is to present a methodology for the systematic design of the Ravigneaux-type epicyclic gear transmissions for automobiles. First, fundamentals and gear-shifting operations of the four-speed, and six-speed epicyclic-type automatic transmissions are illustrated to establish the design requirements. Second, based on the kinematic nomographs of the corresponding basic gear ratios, a simple clutching-sequence method is proposed and illustrated. Next, a planar-graph representation is presented to arrange the desired clutches for each possible clutching sequence into the epicyclic gear mechanism. Then, with the above methods, the systematic designs of the epicyclic gear mechanisms are given for demonstrating the feasibility of the proposed methodology. The result of this work shows that the seven-, eight- and nine-link two-DOF Ravigneaux-type epicyclic gear mechanisms could reach four-, six-, and eight-forward speeds at most, respectively.

The methodology can be applied to any transmission mechanism depending on its kinematic and geometric constraints. New five-, six-, seven- and eight-velocity automatic transmissions are enumerated from the two-ring eight- and nine-link Ravigneaux gear mechanisms. It is a major breakthrough to design completely satisfactory eight-speed automatic transmissions from the nine-link Ravigneaux gear mechanism.

KEYWORDS: Automatic Transmission, Clutching-Sequence, Epicyclic Gear Train, Eight-Velocity, Feasibility Graphs, Nomographs, Ravigneaux Gear Set, Systematic Design.

استخدام مخططات النوموغراف ومخططات الجدوى في تصميم آليات نقل الحركة الآلية

نوع-رافكنوز

م.د. عصام العيبي اسماعيل

جامعة القادسية/كلية الهندسة

NOMOGRAPHS AND FEASIBILITY GRAPHS FOR ENUMERATION OF RAVIGNEAUX-TYPE AUTOMATIC TRANSMISSIONS

الموجز

آلية نقل الحركة هي الوسيلة التي تقوم بربط ماكنه الاحتراق الداخلي بالعجلات. وتحافظ على عمل ماكنه الاحتراق الداخلي ضمن مدى محدد من السرعة الدورانية. وعلى الرغم من وجود الكثير من آليات نقل الحركة كواكبية النوع ، فإن طرق التصميم ذات الصلة ما زالت مريكة وعرضه للاخطاء البشرية ، ومن الضروري تطوير طريقه تصميميه بسيطه. لذلك فإن من اهداف الدراسه تقديم طريقه منهجيه لتصميم آليات نقل الحركة نوع-رافكنوز للسيارات الحديثه. اولاً : أيضاح المبادئ الاساسيه لعمليات تبديل التروس لآليات نقل الحركة ذات السرعة الاربعه او ذات الست سرعة للتعرف على المتطلبات التصميميه. ثانياً : وبالاعتماد على مخططات النوموغراف الحركيه فقد تم اقتراح وأيضاح طريقه بسيطه لتعداد تعاشيق التروس المختلفه. بعدها تقديم تمثيل بمخطط مستوي لترتيب القوابض المرغوبه لكل تتابع التعاشيق الممكنه لآلية نقل الحركة. ثم ، وباستخدام الاساليب المذكوره اعلاه ، تم استعراض منهجية تصاميم آليات نقل الحركة الحاليه لاثبات جدوى المنهجيه المقترحه. وقد بينت نتائج الدراسه الحاليه بأن آليات نقل الحركة نوع رافكنوز ذات السبع والثمان والتسع صلوات يمكن ان تعطي اربع او ست او ثمان سرعة اماميه على التتابع. ويمكن تطبيق الطريقه على اي آليه نقل حركه اخرى بالاعتماد على قيودها الحركيه والهندسيه. وقد تم تعداد آليات نقل حركه جديده ذات خمس- ، ست- ، سبع- ، وثمان سرعة من آليات رافكنوز ذات الثمان والتسع صلوات والترسين الداخليين. وهو تقدم كبير ان يتم تصميم آليات نقل حركه ذات ثمان سرعة من آليه رافكنوز الترسيه ذات الوصلات التسع.

INTRODUCTION

For a long time automatic transmissions with planetary gear trains are used in the automotive industry. Ravigneaux in 1940 proposed seven- and eight-link two-degree-of-freedom (DOF) epicyclic gear mechanisms [1, 2]. These epicyclic gear mechanisms are called the Ravigneaux gear mechanisms. **Figure 1** shows an automatic transmission which provides three forward speeds and one reverse speed [3]. It consists of a seven-link two-DOF Ravigneaux gear mechanism, two rotating clutches C_1 and C_2 and two band clutches B_1 and B_3 . In the associated clutching sequence Table, X_i indicates that the corresponding clutch is activated on the i^{th} link for that gear. The ranges of output velocities are classified into two kinds: under drive (UD) and reverse drive (RD) according to whether the velocity is between zero and the input velocity, or less than zero. A "direct drive" (DD) is equal to the input velocity.

The seven-link two-DOF Ravigneaux gear train has been developed by nearly all automotive manufacturers as three- or four-velocity automatic transmission [3]. It can be found in Ford C3, Ford C5, Mercedes Benz, Toyota A40 and Nissan, to name a few three-velocity automatic transmissions. It can also be found in KM 175 and 176, Ford AOD, ZF 4 HP 14 and Borg-Warner [4], to name a few four-velocity automatic transmissions [5]. **Figure 2** shows the ZF 4 HP 14 automatic transmission [6], which can provide four forward speeds and one reverse speed.

Sometimes, the seven-link two-DOF Ravigneaux gear train is integrated with a simple epicyclic gear train to form ten-link three-DOF epicyclic gear mechanisms to enhance the number of speeds [6, 7], providing six forward speeds. **Figure 3** shows Lepelletier automatic transmission and its clutching sequence table [8]. A widespread gear set concept is that of Lepelletier. This design is based on a single

planetary gear set with rear-mounted Ravigneaux gear set. In 2001, ZF [9] used this gear set design to bring the first 6-speed passenger car transmission 6 HP 26 on the market (**Figure 3**).

Two-DOF eight-link Ravigneaux gear mechanism, shown in **Figure 4** (b) consists of a long pinion and two or more short pinions connecting two sun gears and two ring gears. Unfortunately, two-DOF eight-link Ravigneaux gear trains have been developed as four-velocity automatic transmission [10] while they can be used to produce automatic transmissions having more than four speeds. This work in part will attempt to attain maximum sequential velocity ratios for any given epicyclic gear train.

A seven-link 2-DOF Ravigneaux gear mechanism, an eight-link 2-DOF Ravigneaux gear mechanism and a nine-link 2-DOF stepped Ravigneaux gear mechanism are shown in **Figure 4**, respectively.

The literature on the design of planetary gear trains includes conceptual designs, kinematic analysis, power flow and efficiency analysis, and configuration designs. However, relatively little work has been done on the enumeration of clutching sequences and configuration design of EGMs. This paper presents a systematic procedure to enumerate clutching sequences and to find feasible clutch layouts for Ravigneaux planetary gear trains.

LITERATURE REVIEW

The selection of an optimal clutching sequence can not be solved analytically. **Nadel et al.**[11-13] formulated the task as a constraint satisfaction problem. **Hsieh and Tsai** [14, 15], **Hwang and Huang** [16] and **Hsu and Huang** [17] used algorithmic techniques. **Ross and Route** [18] and **Esmail** [19] introduced graphic techniques. **Hattori et al.** [20] used phase geometry method.

Nadel et al. applied an artificial intelligence technique to enumerate clutching sequences for EGMs made up of two basic epicyclic gear trains. The artificial intelligence technique is a powerful tool for solving the transmission design problem. However, the technique assumes that the design variables have discrete values in prescribed domains. Furthermore, it requires a search over the entire feasible solution space. This methodology is suitable for PGTs in which two simple PGTs are combined. These shortcomings inevitably reduce the efficiency of the algorithm.

Hattori et al. [20] proposed twenty three phase geometric patterns for five-speed Automatic transmissions, each could provide four clutching sequences. Each feasible clutching sequence obtained could be used to construct a clutch layout. However, this approach is suitable only for PGTs consisting of two sun gears, two ring gears and one to three meshed planet gears mounted on a common arm.

Ross and Route [18] introduced a design tool based on a lever analogy. It includes calculation of gear ratios, gear trains selection, and the construction of clutch layouts for parallel-connected PGTs. **Hwang and Huang** [16] and **Hsu and Huang** [17] used similar methods to that used by **Hsieh and Tsai** [14] to enumerate the clutching sequences of two-DOF eight-link Ravigneaux gear mechanism. Moreover, the five studies cited above are restricted to constructing clutch layouts of automatic transmissions for specific types of PGTs.

Hsieh and Tsai [14] used the concept of fundamental gear entities (FGEs) proposed by **Chatterjee and Tsai** [21] in conjunction with their earlier kinematic study [22] to determine the most efficient clutching sequence associated with automatic transmission [15]. They applied combinatorial enumeration procedure to arrange the velocity ratios in a descending sequence. Then, they used an algorithm to enumerate clutching sequences for EGMs composed of two or more FGEs. A computer algorithm for the enumeration of clutching sequences is given by **Hsieh** [23]. The algorithm needs information containing the approximate gear sizes arranged in a descending order.

Most combinatorial enumeration procedures are done through the process of generating and testing. The procedure is thus divided into two parts: a generator of all possible solutions and a tester that selects only those solutions that meet the constraints. An important issue in using a generating and testing technique is the distribution of knowledge between the generator and tester. The generator produces solutions satisfying some of the constraints. The tester then selects those solutions that satisfy the rest of the constraints. While this technique is valid for solving transmission design problems, it

NOMOGRAPHS AND FEASIBILITY GRAPHS FOR ENUMERATION OF RAVIGNEAUX-TYPE AUTOMATIC TRANSMISSIONS

limits the solutions to the knowledge (information) contained in the generator and tester. This inevitably reduces the efficiency of this solution technique and needs complicated computer-algorithm. Usually, putting more knowledge in the generator, results in a more efficient procedure. Nevertheless, **Hsieh and Tsai [14]** did not develop an effective method of arranging clutch layouts for the synthesized clutching sequences. However, the elimination of invalid clutching sequences was conducted by inspection. Identifying invalid clutching sequences by inspection is not always reliable.

Esmail [19] proposed a methodology, based on nomographs, for the enumeration of the associated clutching sequence table for an epicyclic gear mechanism. This method simplifies the synthesis of the clutching sequence of an epicyclic gear mechanism efficiently.

Without careful examination, a clutching sequence may be mistaken for a usable clutch layout for an automatic transmission. **Hsu and Huang [17]** proposed a planar-graph representation to arrange the desired clutches for each possible clutching sequence into the Ravigneaux gear mechanism. **Hwang and Huang [24]** introduced coded sketches for connecting clutch elements to planetary gear trains for automotive automatic transmissions.

The literature survey reveals that although some studies are made on the clutching sequence synthesis, they are all tedious. A simple methodology for the design of planetary automatic transmission needs to be developed. In this paper nomographs are used to synthesis the clutching sequences of Ravhgneaux gear trains; the nomograph method is described in a series of previous papers [19, 25 and 26]. Only the related topics needed in this paper will be reviewed wherever appeared.

In this paper, more efficient solution techniques are developed to overcome those shortcomings. This paper applies kinematic nomographs [19, 25] and feasibility graphs [17] of Ravigneaux gear trains to achieve the goal. By virtue of these solution techniques, completely satisfactory six- and eight-speed automatic transmissions are designed from the eight- and nine-link Ravigneaux gear mechanism, respectively.

ENUMERATION OF ALL FEASIBLE CLUTCHING SEQUENCES WITH THE AID OF NOMOGRAPH

The first stage of designing epicyclic-type automatic transmissions is to synthesize all possible clutching sequences from the epicyclic-gear mechanism. Nomographs are used for this purpose.

Nomographs and Geometry Relations for Seven- Link Ravigneaux gear train

A nomograph is defined as three or more axes, or scales, arranged such that problems of three or more variables can be solved using a straightedge. In the particular case of EGTs, a nomograph can be constructed using three or more vertical parallel axes [19 and 27].

Traditionally, the velocity ratio is used to study the velocity relations among the different links of an EGT [3].

Let the symbol $R_{x,y}^z$ denote the velocity ratio between links x and y with reference to link z where x , y and z are any three links in the gear train, then

$$R_{x,y}^z = \frac{\omega_x - \omega_z}{\omega_y - \omega_z} \quad (1)$$

Since the gear mechanism, shown in **Figure 4** (a) is a double-planet FGE then its nomograph can be drawn in terms of planet gear 6 as shown in **Figure 5**.

The term "gear ratio" is used in this paper to denote the ratio of a meshing gear pair. It is defined by the ratio of a planet gear p with respect to a sun or ring gear x

$$N_{p,x} = \mp Z_p / Z_x \quad (2)$$

Where Z_p and Z_x denote the numbers of teeth on the planet and the sun or ring gear, respectively, and the positive or negative sign depends on whether x is a ring or sun gear.

Considering the kinematics of a fundamental circuit, the fundamental circuit equation can be written as [19]:

$$(\omega_x - \omega_c) / (\omega_p - \omega_c) = N_{p,x} \quad (3)$$

Equation (3) can be re-written for ring, sun, planet gears and carrier to obtain $N_{p,r}$, $N_{p,s}$, $N_{p,p}$ and $N_{p,c}$, respectively. The gear ratio for small sun gear s_s that is not meshing directly with the first planet gear p on which the nomograph is drawn and is meshing with the second planet gear p_1 can be found in terms of the gear ratio of the two planets N_{p,p_1} as

$$N_{p,s_s} = N_{p,p_1} \cdot N_{p_1,s_s} \quad (4)$$

The values of the gear ratios are used to place the axes of the nomograph shown in **Figure 5**. The ω_c axis passes at the origin, and the ω_p axis is one unit apart from it.

The gear ratios for the Ravigneaux gear train are

$$N_{6,5} = -Z_6 / Z_5 \quad (5)$$

$$N_{5,2} = -Z_5 / Z_2 \quad (6)$$

$$N_{6,1} = -Z_6 / Z_1 \quad (7)$$

And

$$N_{6,4} = Z_6 / Z_4 \quad (8)$$

Considering the geometry relations of the Ravigneaux gear mechanism given in equations (5) through (8), the values of the gear ratios can be deduced as following:

$$-\infty \leq N_{6,5} \leq 0 \quad (9)$$

$$-\infty \leq N_{5,2} \leq 0 \quad (10)$$

$$-\infty \leq N_{6,1} \leq 0 \quad (11)$$

and

$$0 \leq N_{6,4} \leq 1 \quad (12)$$

From Eq. (4), we can write

$$N_{6,2} = N_{6,5} \cdot N_{5,2} \quad (13)$$

$$N_{6,2} = Z_6 / Z_2 \quad (14)$$

NOMOGRAPHS AND FEASIBILITY GRAPHS FOR ENUMERATION OF RAVIGNEAUX-TYPE AUTOMATIC TRANSMISSIONS

Since Z_4 is greater than Z_2 then from equations (8) and (14) it can shown that

$$N_{6,2} > N_{6,4} \quad (15)$$

2.2. Enumeration of all Feasible Clutching Sequences

Kinematic relationships among the links of this FGE can easily be visualized by observation from the nomograph shown in **Figure 5**. Any straight line through the input operating velocities of the EGT will intersect other axes at the operating velocities of the links representing to those axes. From the nomograph $R_{x,y}^z$ can be written as [19]

$$R_{x,y}^z = \frac{N_{p,x} - N_{p,z}}{N_{p,y} - N_{p,z}} \quad (16)$$

Because there are four coaxial links and link four is pre-assigned as the output link, this gear train can provide six overall velocity ratios [27 and 28]. **Figure 6** shows the clutching sequence nomograph for this mechanism.

In arranging a clutching sequence, it is highly desirable to achieve a single-shift transition [19]. In order to achieve single-shift transitions, the UD's can be further classified into two sets. The OD's and RD's are used with both of the UD sets.

A direct drive is obtained by simultaneously clutching two coaxial links of an EGT to the input power source. A reverse drive can be obtained by applying one or two of the clutches designed for the forward drives to the reverse drive.

As a result, we obtain two descending sequences of velocities as shown in **Figures 7 (a) and (b)**, which result in two three-velocity and two four-velocity clutching sequences.

2.3. Feasibility Graphs for an Epicyclic Gear Train to Form an Automatic Transmission

A graphical representation is proposed by [17] to easily and quickly detect the possibility of the arrangement of all the rotating clutches and band clutches into the gear mechanism to forming an automatic transmission.

A graph that can be drawn on a plane such that no two of its edges intersect is called planar; meaning it can form an automatic transmission. A graph that cannot be drawn on a plane without crossover between its edges is called non-planar, meaning there is no possibility to form an automatic transmission. Here we shall call such graphs as the feasibility graphs of a gear train to form an automatic transmission. They are shown in **Figure 8 (a) through (d)**.

As a result, all of the four sets of clutching sequences are feasible to form automatic transmissions, and the corresponding four-velocity automatic transmissions are drawn, as shown in **Figures 9 (a) through (d)**, respectively.

Figure 9 (a) shows one feasible clutching sequence with rotating clutches attached to links 1 and 2, and band clutches attached to links 1 and 3. This clutching sequence has been applied in most three-velocity Ravigneaux automatic transmission [3 and 6]. The other clutching sequences obtained are in agreement with those reported in the literature [5, 14, 23], except that there is no need to any information containing the approximate gear sizes arranged in a descending order.

Nomographs and Geometry Relations for Eight- Link Ravigneaux gear train

Figure 10 shows the nomograph of the mechanisms shown in **Figure 4 (b)**.

The gear ratios for the eight-link Ravigneaux gear train are the same as that for the seven-link given before. In addition the gear ratio for the added small ring gear can be written as following:

$$N_{5,7} = Z_5 / Z_7 \quad (17)$$

It can be concluded that $0 \leq N_{5,7} \leq 1$. From Eq. (4), we can write

$$N_{6,7} = N_{6,5} \cdot N_{5,7} \quad (18)$$

Therefore;

$$N_{6,7} = -Z_6 / Z_7 \quad (19)$$

Since Z_7 is greater than Z_1 then from equations (7) and (19)

$$N_{6,7} > N_{6,1} \quad (20)$$

Enumeration of all Feasible Clutching Sequences

Because there are five coaxial links and link four or seven can be assigned as the output link, this gear train can provide twelve overall velocity ratios for each assignment. **Figure 11** shows the clutching sequence nomograph for this mechanism.

In order to achieve single-shift transitions, the UDs can be further classified into two sets. By adding a direct drive and two ODs, a total of four six-velocity sets are obtained. A direct drive is obtained by simultaneously clutching two coaxial links of an EGT to the input power source. As a result, we obtain four descending sequences of velocities as shown in **Figure 12**.

A reverse drive can be obtained by applying one or two of the clutches designed for the forward drives to the reverse drive.

If a reverse drive is added three six-velocity clutching sequences can be enumerated for each set which result in twelve six-velocity clutching sequences. For the small ring to be an output link another twelve six-velocity clutching sequences can be enumerated.

The first set can realize six-speed automatic transmission, while having three clutches and three brakes only.

Feasibility Graphs for the Two-Ring Epicyclic Gear Train to Form an Automatic Transmission

The feasibility graphs of the eight-link Ravigneaux gear train to form automatic transmissions are shown in **Figure 13 (a) and (b)**.

Figure 13 (a) reveals that only a clutch can be attached to link 2. For the first and second sets of clutching sequences shown in **Figures 12 (a) and (b)**, they are controlled by $C_1, C_2, C_3, C_7, B_1, B_2$ and B_7 . As a result, all of the six clutching sequences that can be obtained from the first and second sets are feasible to form automatic transmissions.

Figure 13 (b) reveals that only a band clutch can be attached to link 1. The third and fourth sets of clutching sequences shown in **Figures 12 (c) and (d)** are controlled by $C_1, C_2, C_3, C_7, B_1, B_2, B_3$ and B_7 . As a result by excluding C_1 from the clutching sequences nomograph, two clutching sequences are feasible to form five-velocity automatic transmissions.

Figure 12 (d) shows a clutching sequence nomograph without reverse drive based on the fourth reduction set. By excluding C_1 from the clutching sequence nomograph, a five-velocity automatic transmission is possible. **Figure 14** shows the corresponding functional representation, with a band clutch B_3 attached to link 3 for reverse drive. The input clutches C_7 and band clutch B_3 are applied for the reverse drive.

NOMOGRAPHS AND FEASIBILITY GRAPHS FOR ENUMERATION OF RAVIGNEAUX-TYPE AUTOMATIC TRANSMISSIONS

Nomographs and Geometry Relations for Nine-Link Ravigneaux gear train

Figure 15 shows the nomograph of the mechanisms shown in **Figure 4 (c)**.

The gear ratios for the stepped nine-link Ravigneaux gear train are the same as those for the seven- and eight-link gear trains given before, except that the gear ratios are written in terms of the plant to which it is meshing, either gear 6 or 6^1 of the stepped plant.

$$N_{6^1,7} = -Z_{6^1}/Z_7 \quad (21)$$

In addition, the gear ratio for the added third sun gear can be written as: $N_{6^1,8} = -Z_{6^1}/Z_8$

Since Z_7 is greater than Z_1 and Z_6 is greater than Z_6^1 then from equations (7) and (21) it can be shown that

$$N_{6^1,7} > N_{6,1} \quad (22)$$

Similarly $N_{6^1,8} > N_{6,1}$ and $N_{6^1,7} > N_{6^1,8} > N_{6,1}$. Moreover

$$N_{6^1,2} = Z_{6^1}/Z_2 \quad (23)$$

Since Z_4 is greater than Z_2 and Z_6 is greater than Z_6^1 then from equations (8) and (23) it can be shown that these gear ratios work oppositely; while one increase the gear ratio, the other decrease it, but, without loss of generality, we can select the most probable case where $N_{6^1,2} > N_{6,4}$.

Because there are six coaxial links and link four or eight can be assigned as the output link, this gear train can provide twenty overall velocity ratios for each assignment. The velocity ratios are classified into three groups; under-drive, over-drive and reverse drive. If there are more than two sets of velocity ratios in any group, they are further classified into all possible sets or subgroups based on the constraint that only one clutch can be shifted in each set. The velocity ratios in any set are arranged in a descending order, and then the corresponding clutching sequence is generated. Possible clutching sequences are generated by combining the UD, DD, OD, and RD subgroups together. **Figure 16** shows the clutching sequence nomograph for the nine-link Ravigneaux gear mechanism shown in **Figure 4 (c)**.

In order to achieve single-shift transitions, the UD velocities are classified into two sets (shown in **Figure 17**).

For the first set, the UD clutching sequences shown in **Figure 17 (a)**, are controlled by C_2, B_1, B_3, B_7 and B_8 , while those for the second set shown in **Figure 17 (b)**, are controlled by B_2, C_1, C_3, C_7 and C_8 .

The feasibility graphs of the nine-link Ravigneaux gear train to form automatic transmissions are shown in **Figures 18 and 23**.

For the first UD set, the clutching sequences, shown in **Figure 18**, are controlled by $C_2, C_3, C_7, C_8, B_1, B_3, B_7$ and B_8 . As a result, all of the UD and OD clutching sequences that can be obtained from the first set are feasible to form automatic transmissions. The RDs are only obtained from one of the rotating clutches C_7 or C_8 and one of the band clutches B_3 or B_7 .

Figure 18 reveals that a clutch can not be attached to link 1, thus, the last three reverse clutching sequences shown in **Figure 17 (a)** are inadmissible. As a result, only thirteen clutching sequences shown in **Figure 19** are feasible at this design stage.

Based on the first UD set of feasibility graph, the general clutching sequence layout for the nine-link Ravigneaux gear train is shown in **Figure 20**. All of the eight-velocity feasible clutching sequence layouts can be extracted from this general layout.

In order to achieve single-shift transitions, the ODs can be further classified into five sets; three sets consist of three-over-drives and two sets consist of two-over-drives.

By combining the first set of UD clutching sequences with three sets of three-velocity OD clutching sequences and three sets of RDs, nine possible clutching sequences for eight-velocity automatic transmissions are feasible at this design stage as shown in **Figure 21**.

Moreover, the first set of UD clutching sequences can also be combined with two sets of two-velocity OD clutching sequences and three sets of RDs, six possible clutching sequences for seven-velocity automatic transmissions are feasible at this design stage, as shown in **Figure 22**.

For the second set, since B_2 is essential for the UD clutching sequences, then only band clutches can be attached to links 1 and 8 as shown in **Figure 23**. Therefore, the clutching sequences are controlled by C2, C3, C7, B1, B2, B3, B7 and B8. The clutch C2 has no role in the clutching sequence. As a result by excluding C2, three clutching sequences are feasible to form six-velocity automatic transmissions.

In order to achieve single-shift transitions, the ODs can be further classified into three sets consisting of three-over-drives.

By combining the second set of UD clutching sequences with the three sets of three-velocity OD clutching sequences and the one RD, three possible clutching sequences for six-velocity automatic transmissions are feasible at this design stage as shown in **Figure 25**.

Based on the second UD set of feasibility graph, the general clutching sequence layout for the nine-link Ravigneaux gear train to form six-velocity Ravigneaux gear mechanisms is shown in **Figure 26**.

CONCLUSIONS

A novel feature of the suggested approach for constructing multi-axis nomographs is the ability to enumerate the feasible clutching sequences associated with two-ring eight-, and nine-link Ravigneaux-type automatic transmissions. It is a major breakthrough to design a completely satisfactory six-speed automatic transmission from the two-ring Ravigneaux gear train since it has only eight links. Moreover, new eight-speed automatic transmissions are enumerated from nine-link gear mechanisms. The new designs make use of the benefits of the Ravigneaux gear train and overcome the previous art difficulties. The completeness of the results cannot be confirmed since no publications exist for eight-velocity Ravigneaux gear mechanisms. The proposed methodology can be used for the systematic design of any epicyclic-type automatic transmission. Feasibility graphs have been also used as a design tool, allowing the designer to quickly selecting the most viable clutching sequence.

REFERENCES

- [1]Ravigneaux, P., "Gear Box with Freewheeling Gear," U. S. Patent No. 2195783, 1940.
- [2]Ravigneaux, P., "Speed Changing Device," U. S. Patent No. 2220174, 1940.
- [3]Tsai, L.W., "Mechanism Design: Enumeration of Kinematic Structures According to Function", CRC Press, Boca Raton, FL, 2001.
- [4]Wilfinger, E., and Thompson, J., "Borg-Warner Australia Model 85 Automatic Transmission," SAE Paper No. 880480, 1988.
- [5]C.H. Hsu, R.H. Huang, "Systematic design of four-speed ravigneaux-type automatic transmissions," Journal of Chinese Society of Mechanical Engineers 30 (3) pp. 201-209, 2009.

NOMOGRAPHS AND FEASIBILITY GRAPHS FOR ENUMERATION OF RAVIGNEAUX-TYPE AUTOMATIC TRANSMISSIONS

- [6]Naunheimer, H., Bertsche, B., Ryborz, J., Novak, W., "Automotive Transmissions, Fundamentals, Selection, Design and Applications", 2nd ed., DOI 10.1007/978-3-642-16214-5_6, © Springer Berlin Heidelberg, 2011.
- [7]Katou, N., Taniguchi, T., and Tsukamoto, K., "Aisin AW New Six-Speed Automatic Transmission for FWD Vehicles," SAE Paper No. 2004-01-0651, 2004.
- [8] Lepelletier, P. A. G., "Multispeed automatic transmission for automobile vehicles," U. S. patent no. 5106352, 1992.
- [9]Scherer, H., "ZF 6-Speed Automatic Transmission for Passenger Cars," SAE Paper No. 2003-01-0596, 2003.
- [10] Ravigneaux, P., "Epicyclic Change-Speed Gear," U. S. patent no. 2761333, 1956.
- [11]Nadel, B.A. and Lin, J. (1991). Automobile Transmission Design as a Constraint Satisfaction Problem: First Results, Proc. 7th IEEE Conf. on Artificial Intelligence Applications, 1, pp. 248-256.
- [12]Nadel, B.A. and Lin, J. (1991). Automobile Transmission Design as a Constraint Satisfaction Problem: Modeling the Kinematic Level, Artificial Intelligence for Engineering Design, Analysis and Manufacturing, 5, 3, pp. 137-171.
- [13]Nadel, B.A., Wu, X. and Kagan, D. (1993). "Multiple Abstraction Levels in Automobile Transmission Design: Constraint Satisfaction Formulation and Implementation," Int'l. Journal of Expert Systems, 6, 4, pp. 489-559.
- [14]Hsieh, H.I. and Tsai, L.W. (1996), "A Methodology for Enumeration of Clutching Sequences Associated with Epicyclic-Type Automatic Transmission Mechanisms," SAE Transactions, Journal of Passenger Cars, Sec.105, pp. 928-936.
- [15]Hsieh, H.I. and Tsai, L.W., The Selection of Most Efficient Clutching Sequences Associated with Epicyclic-Type Automatic Transmission, ASME J. of Mechanical Design, 120, pp. 514-519, 1998.
- [16]W.M. Hwang, Y.L. Huang, Configuration design of six-speed automatic transmissions with two-degree-of-freedom planetary gear trains, Transactions of the Canadian Society for Mechanical Engineering 29 (1), pp. 41–55, 2005.
- [17]C.H. Hsu, R.H. Huang, "Systematic design of six-speed automatic transmissions with an eight-link two-DOF Ravigneaux gear mechanism," Transactions of the ASME, Journal of Mechanical Design, Volume 13, No. 1, pp. 011004-1–011004-8, 2009.
- [18] C.S. Ross, W.D. Route, A method for selecting parallel-connected, Planetary Gear Train Arrangements for Automotive Automatic Transmissions, SAE Transactions 100 (6) (1991) 1765–1774.
- [19]Esmail, E. L., "Nomographs for enumeration of clutching sequences associated with epicyclic type automatic transmission mechanisms", ASME International Mechanical Engineering Congress and Exposition (IMECE08), October 31- November 6, 2008 Boston, Massachusetts, USA, paper No.66409 also at (Emirates Journal for Engineering Research, Vol. 14, No.1, pp.29-38, 2009).

- [20] N. Hattori, T. Oshidari, Y. Morimono, Application of a new complex planetary gear set to five-speed automatic transmission gear train, Transactions of the Society of Automotive Engineers of Japan 26 (1) (1995) 79–82
- [21] Chatterjee, G. and Tsai, L.W., “Enumeration of Epicyclic-Type Transmission Gear trains,” Transactions of SAE, 103(6), Paper No. 941012, pp. 1415-1426, 1995.
- [22] Hsieh, H. I., and Tsai, L. W., “Kinematic Analysis Of Epicyclic-Type Transmission Mechanisms Using the Concept of Fundamental Geared Entities,” ASME J. of Mechanical Design, 118, pp. 294-299, 1996.
- [23] Hsieh, H.I., “Enumeration and Selection of Clutching Sequences Associated with Epicyclic-Type Transmission Mechanisms,” Ph.D. Thesis, Department of Mechanical Engineering, University of Maryland at College Park, Maryland, USA, 1996.
- [24] W.M. Hwang, Y.L. Huang, “Connecting clutch elements to planetary gear trains for automotive automatic transmissions via coded sketches,” Mechanism and Machine Theory 46, pp. 44–52, 2011.
- [25] Esmail, E.L., “Kinematic Nomographs of Epicyclic-Type Transmission Mechanisms,” Emirates Journal for Engineering Research, Volume 12, No. 3, pp. 47-55, 2007.
- [26] Esmail, E.L., “Nomographs for analysis of power circulation through closed epicyclic gear trains,” Emirates Journal for Engineering Research, Volume 16, No. 2, pp. 1-9, 2011.
- [27] Esmail, E. L. and Hussien, H.A., "Nomographs for Kinematic, Statics and Power Flow Analysis of epicyclic gear trains", ASME International Mechanical Engineering Congress and Exposition (IMECE09), November 13-19, Lake Buena Vista, Florida, USA, Volume 13, paper No. 10789, pp. 631-640, 2009.
- [28] Esmail, E. L., "Teaching Planetary Gear Trains with the Aid of Nomographs", to be published in Advances in Mechanical Engineering Hindawi, Publishing Corporation, 2013.

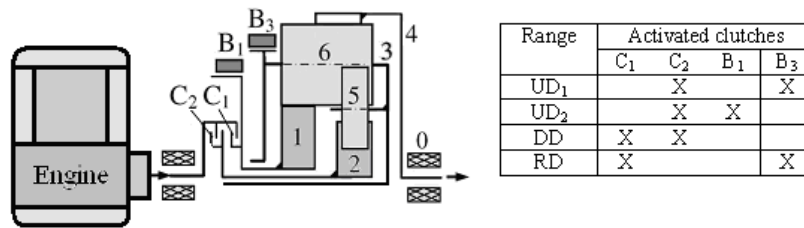
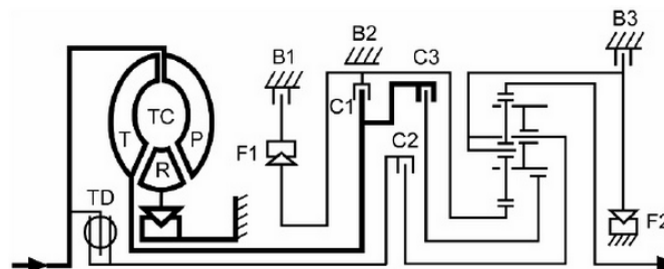

Figure 1 A typical automatic transmission mechanism and its clutching sequence Table.



NOMOGRAPHS AND FEASIBILITY GRAPHS FOR ENUMERATION OF RAVIGNEAUX-TYPE AUTOMATIC TRANSMISSIONS

Figure 2 Gearbox diagram for 2 ZF 4 HP 14 4-speed automatic transmission with Ravigneaux gear set (TC: Trilok converter, P: pump, T: turbine, R: reactor with freewheel, TD: torsion damper, F: freewheels, B: brakes, C: clutches) [6].

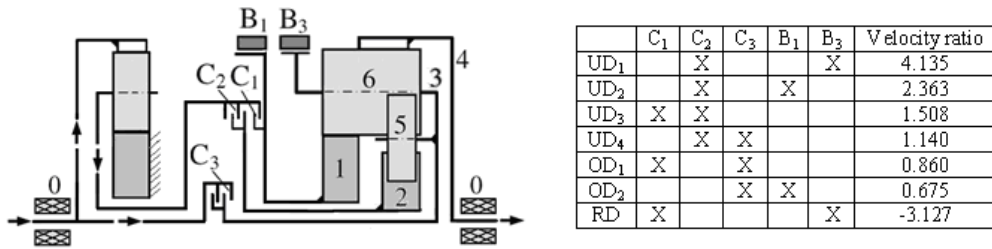

Figure 3 Six-velocity Lepelletier automatic transmission and its clashing sequence table [8].

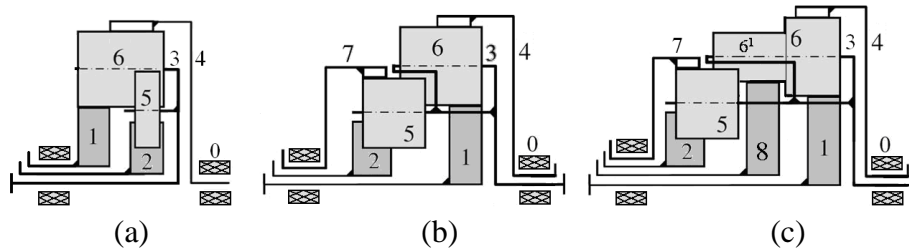

Figure 4 Seven-, eight- and nine-link Ravigneaux gear mechanisms.

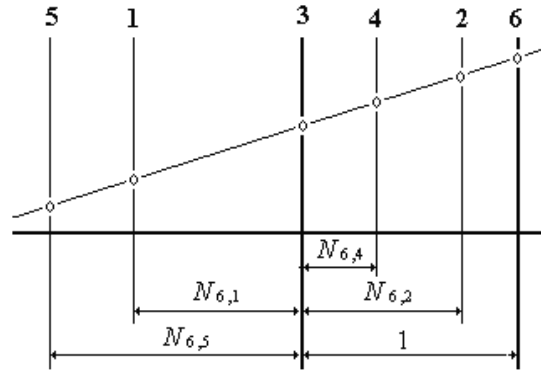

Figure 5 Nomograph for the double-planet FGT shown in Fig. 4 (a), in terms of planet gear 6, as given in ref. [19]

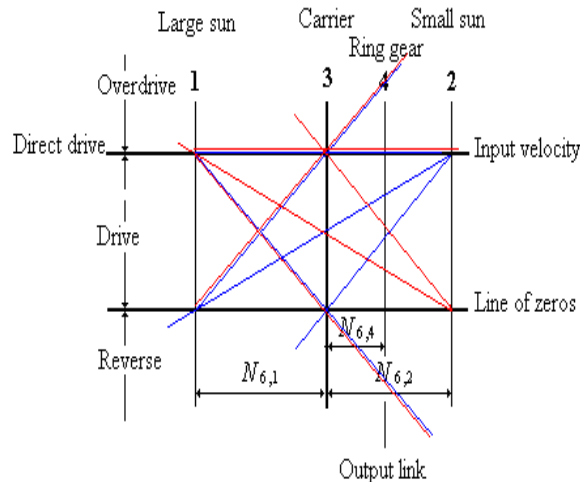

Figure 6: Clutching sequence nomograph for the Ravigneaux gear train.

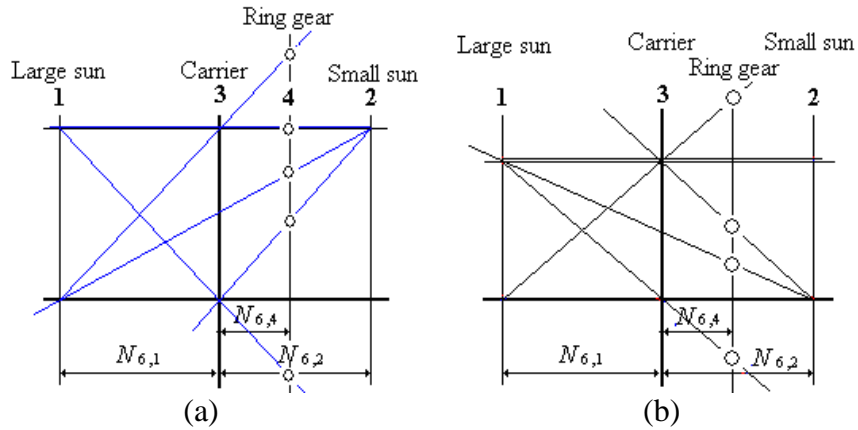

Figure 7: Clutching sequence nomograph for (a) the first reduction set (b) the second reduction set.

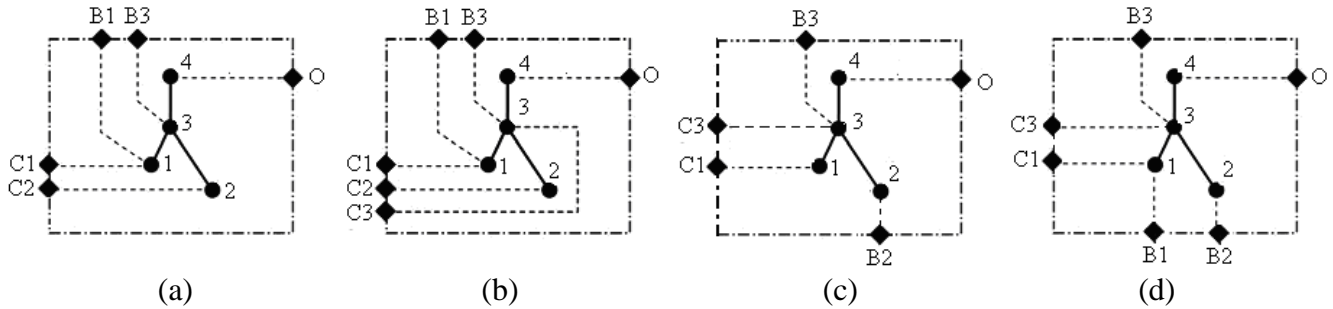

Figure 8: Feasibility graphs for the Ravigneaux gear train to form three- or four-velocity automatic transmissions.

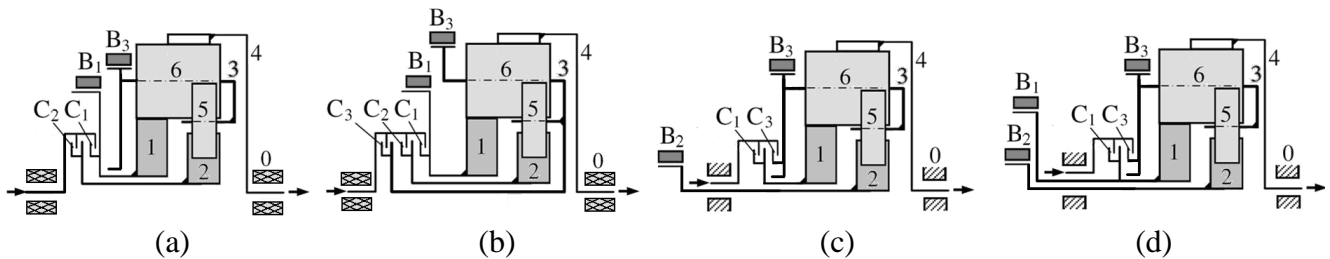

Figure 9: Functional representation of the three- and four-velocity Ravigneaux automatic transmissions.

NOMOGRAPHS AND FEASIBILITY GRAPHS FOR ENUMERATION OF RAVIGNEAUX-TYPE AUTOMATIC TRANSMISSIONS

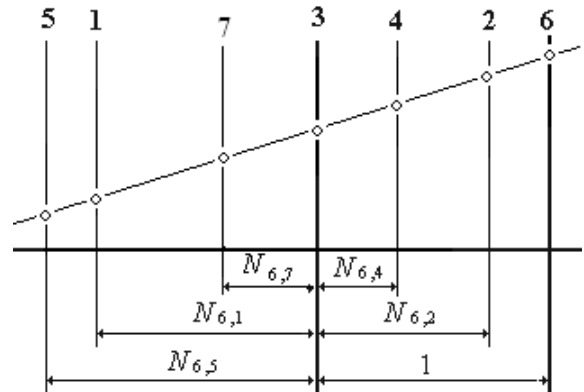

Figure 10 Nomograph for the double-planet FGT shown in **Figure 4 (b)**, in terms of planet gear 6. [19]

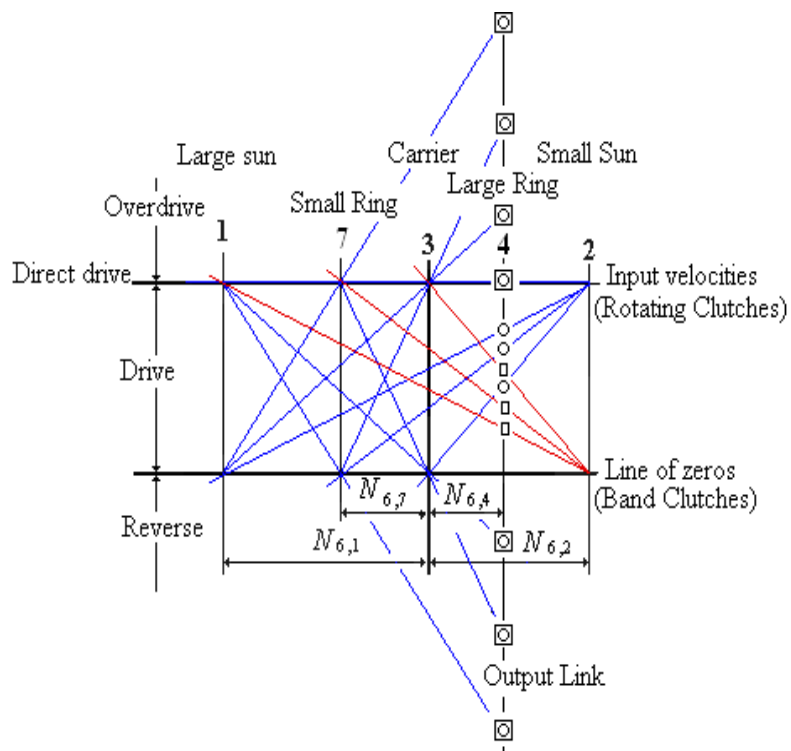

Figure 11 Clutching sequence nomograph for the Ravigneaux gear train shown in **Figure 4 (b)**.

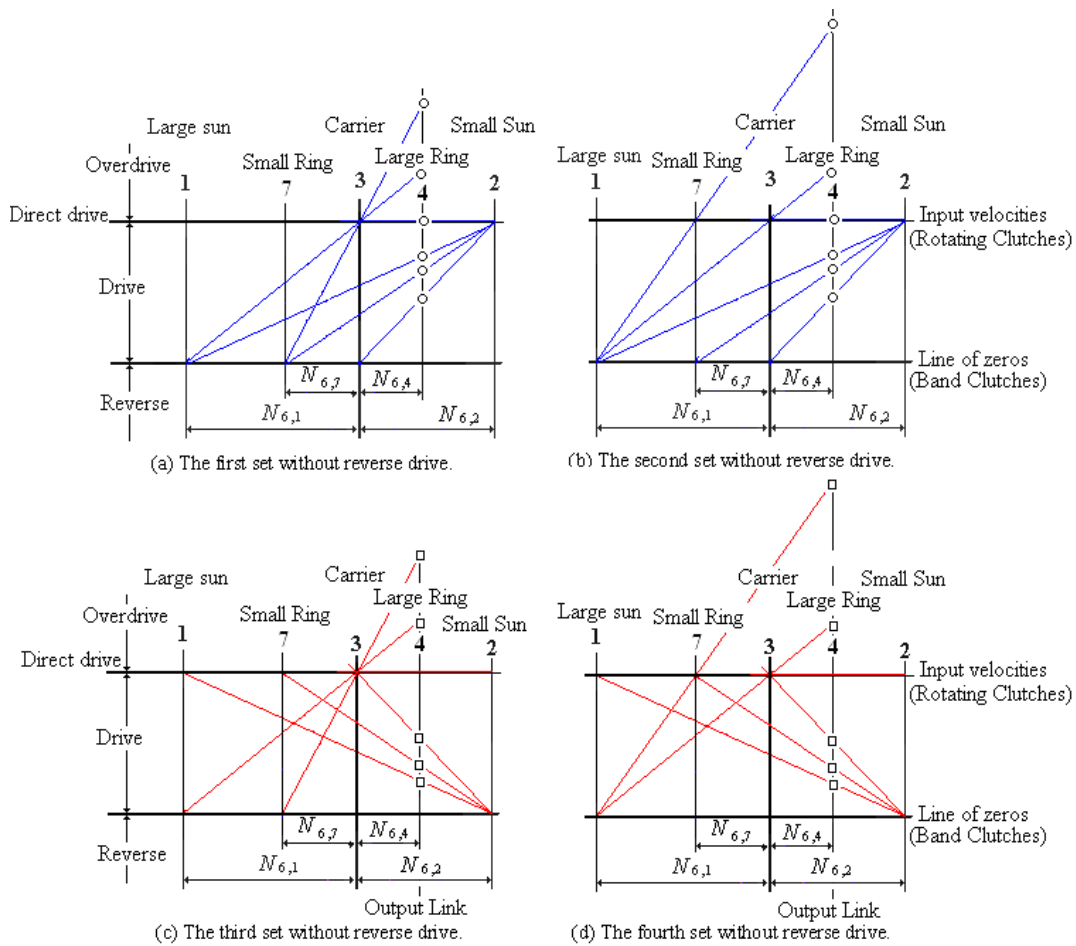

Figure 12 Clutching sequence nomographs for the first, second, third, and fourth sets.

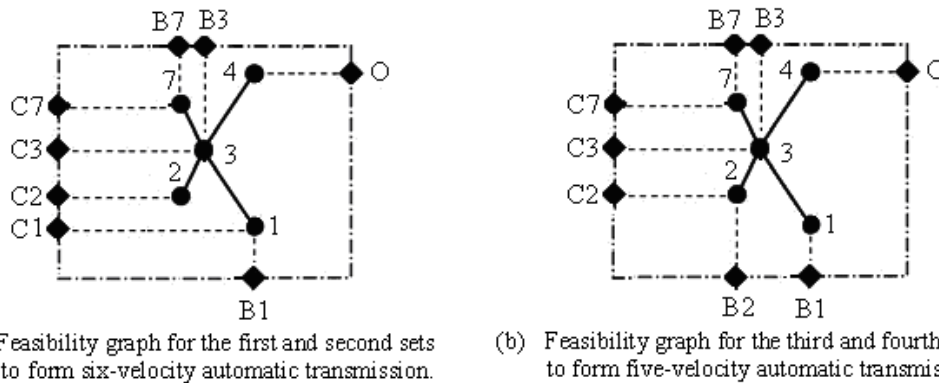

Figure 13 Feasibility graphs for the Ravigneaux gear train to form five- or six-velocity automatic transmissions.

NOMOGRAPHS AND FEASIBILITY GRAPHS FOR ENUMERATION OF RAVIGNEAUX-TYPE AUTOMATIC TRANSMISSIONS

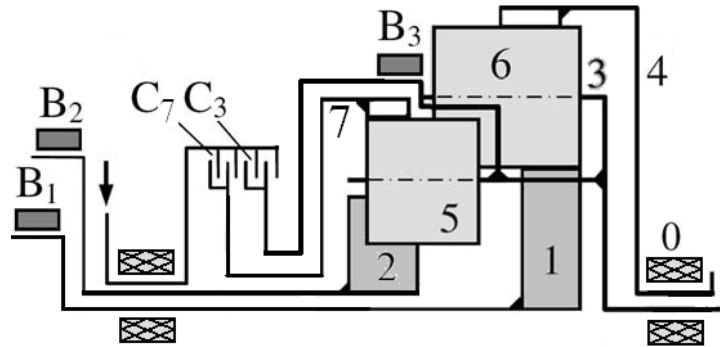

Figure 14 Functional representation of five-velocity Ravigneaux gear train based on the fourth reduction set shown in **Figure 12 (d)**.

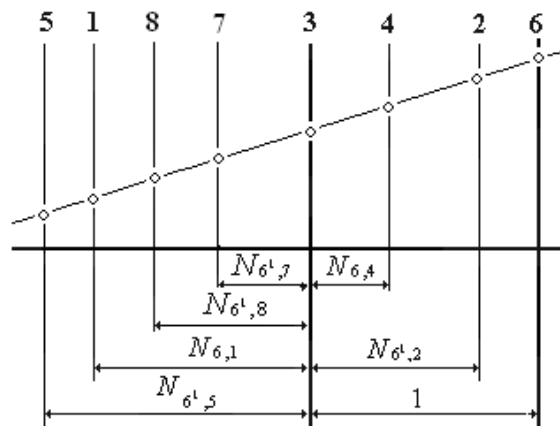

Figure 15 Nomograph for the double-planet FGT shown in **Fig. 4 (c)**, in terms of planet gear 6.

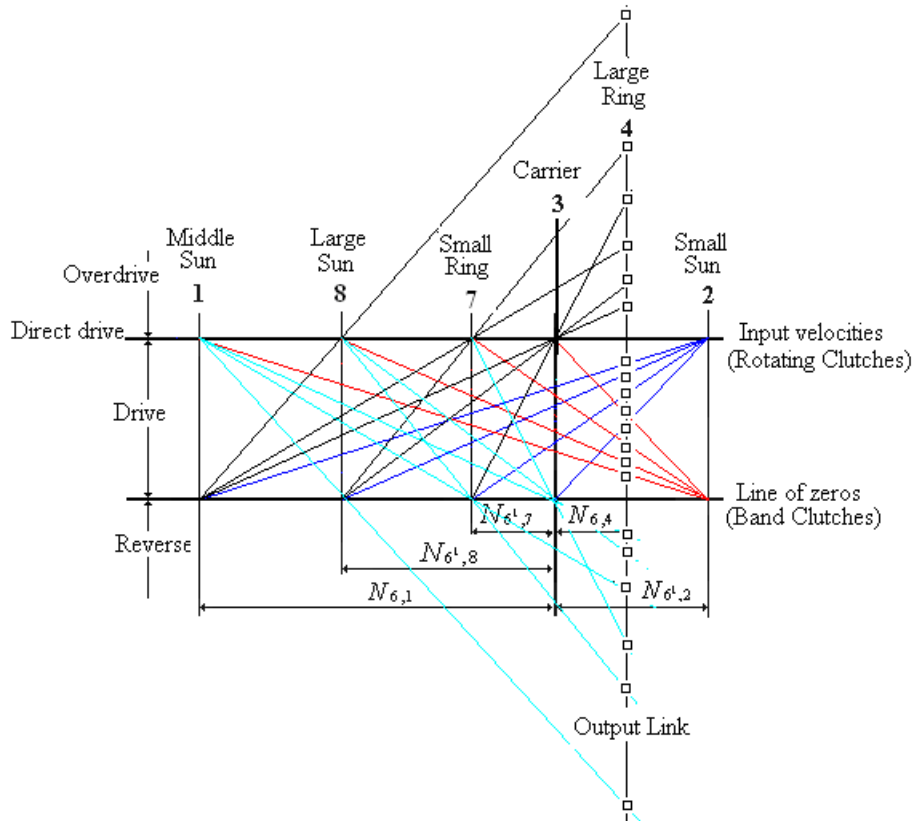

Figure 16 Clutching sequence nomograph for the nine-link Ravigneaux gear train shown in Figure 4 (c).

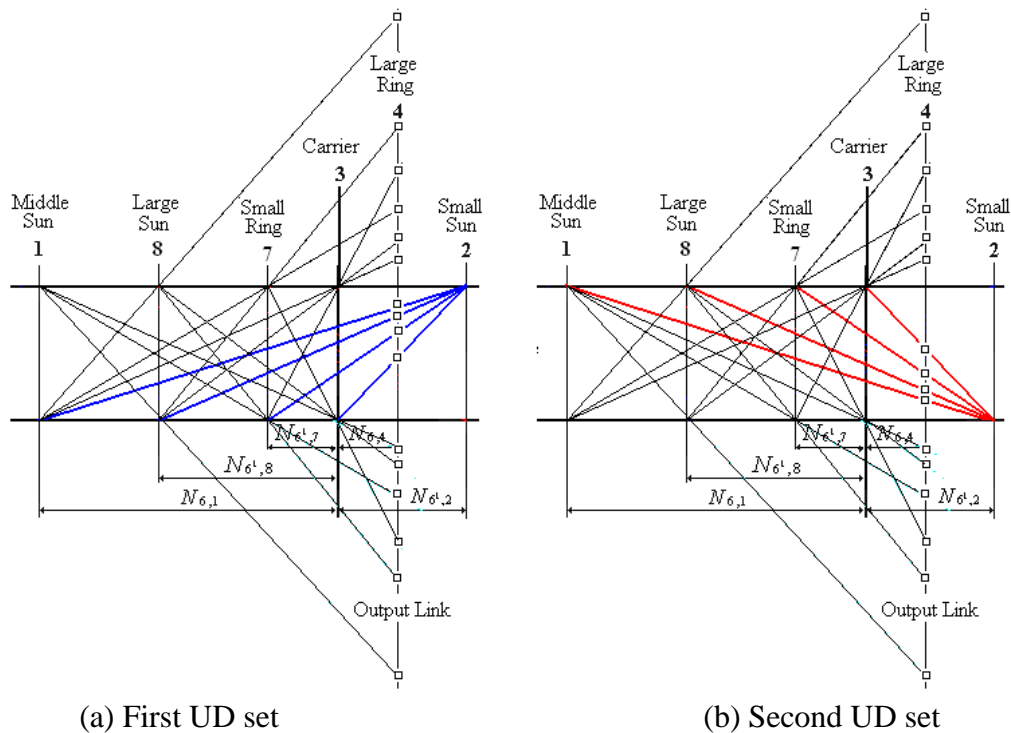

Figure 17 Clutching sequence nomograph for the two UD sets of the nine-link Ravigneaux gear train.

NOMOGRAPHS AND FEASIBILITY GRAPHS FOR ENUMERATION OF RAVIGNEAUX-TYPE AUTOMATIC TRANSMISSIONS

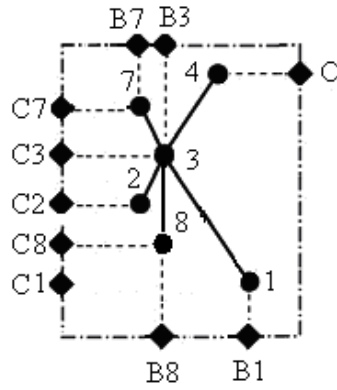

Figure 18 Feasibility graph for the first UD set to form eight-velocity automatic transmission.

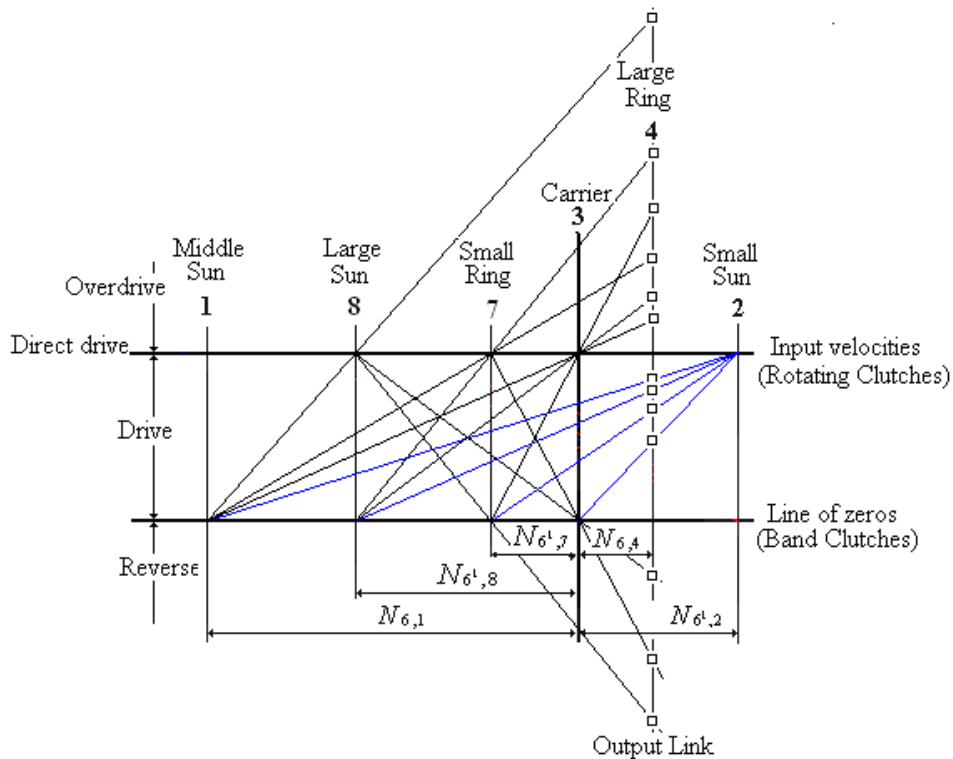

Figure 19 Clutching sequence nomograph for the nine-link Ravigneaux gear train shown in **Figure 4 (c)** based on the feasibility graph.

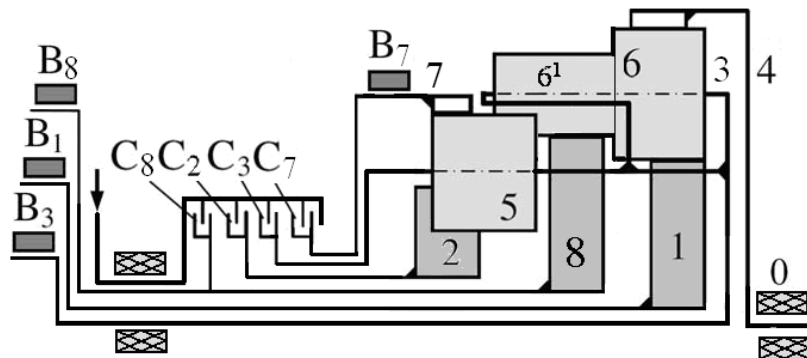

Figure 20 Clutching sequence layout for the nine-link Ravigneaux gear train shown in Figure 4 (c) based on the feasibility graph.

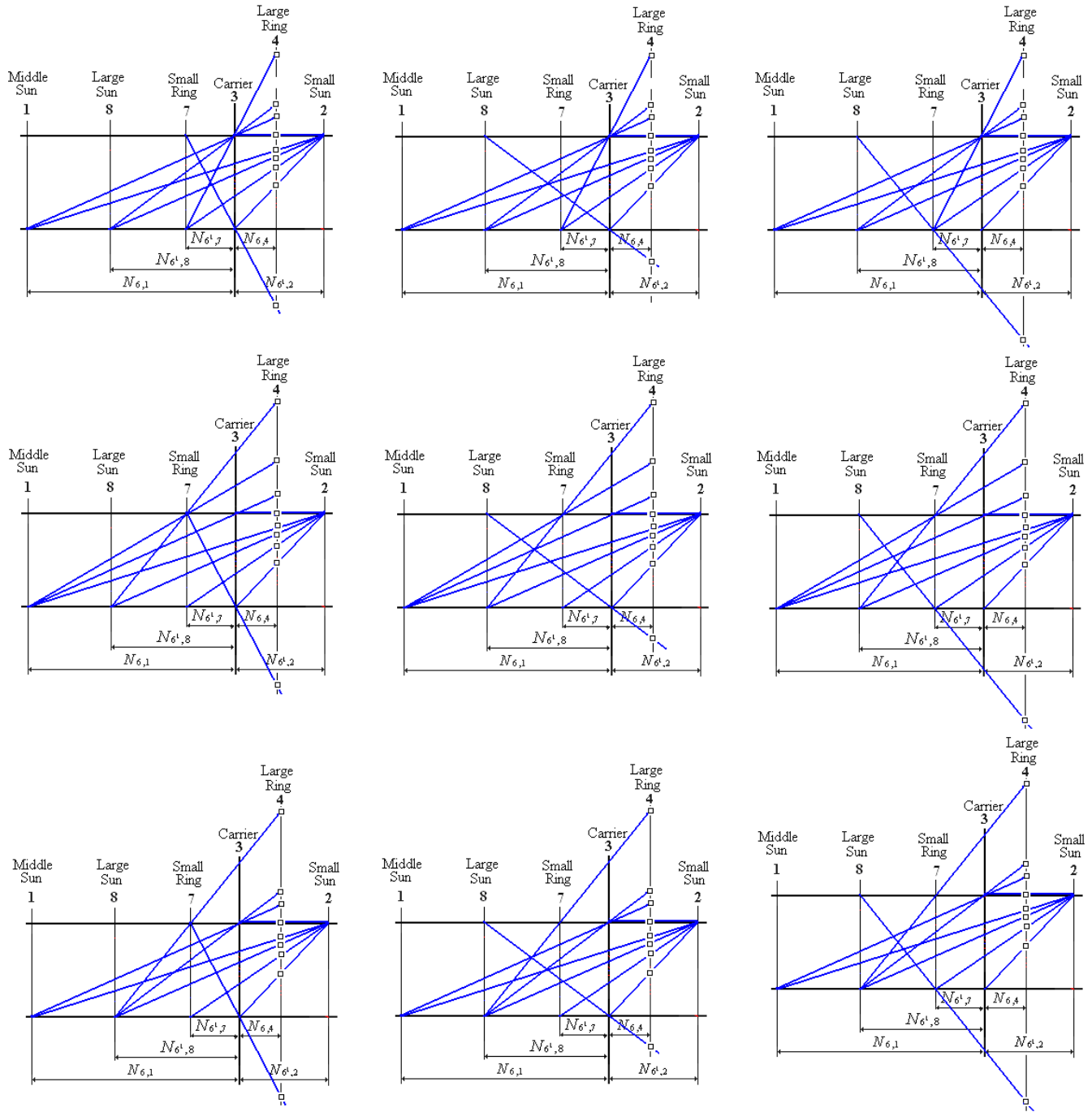

Figure 21 Clutching sequence nomographs for eight-velocity transmissions.

NOMOGRAPHS AND FEASIBILITY GRAPHS FOR ENUMERATION OF RAVIGNEAUX-TYPE AUTOMATIC TRANSMISSIONS

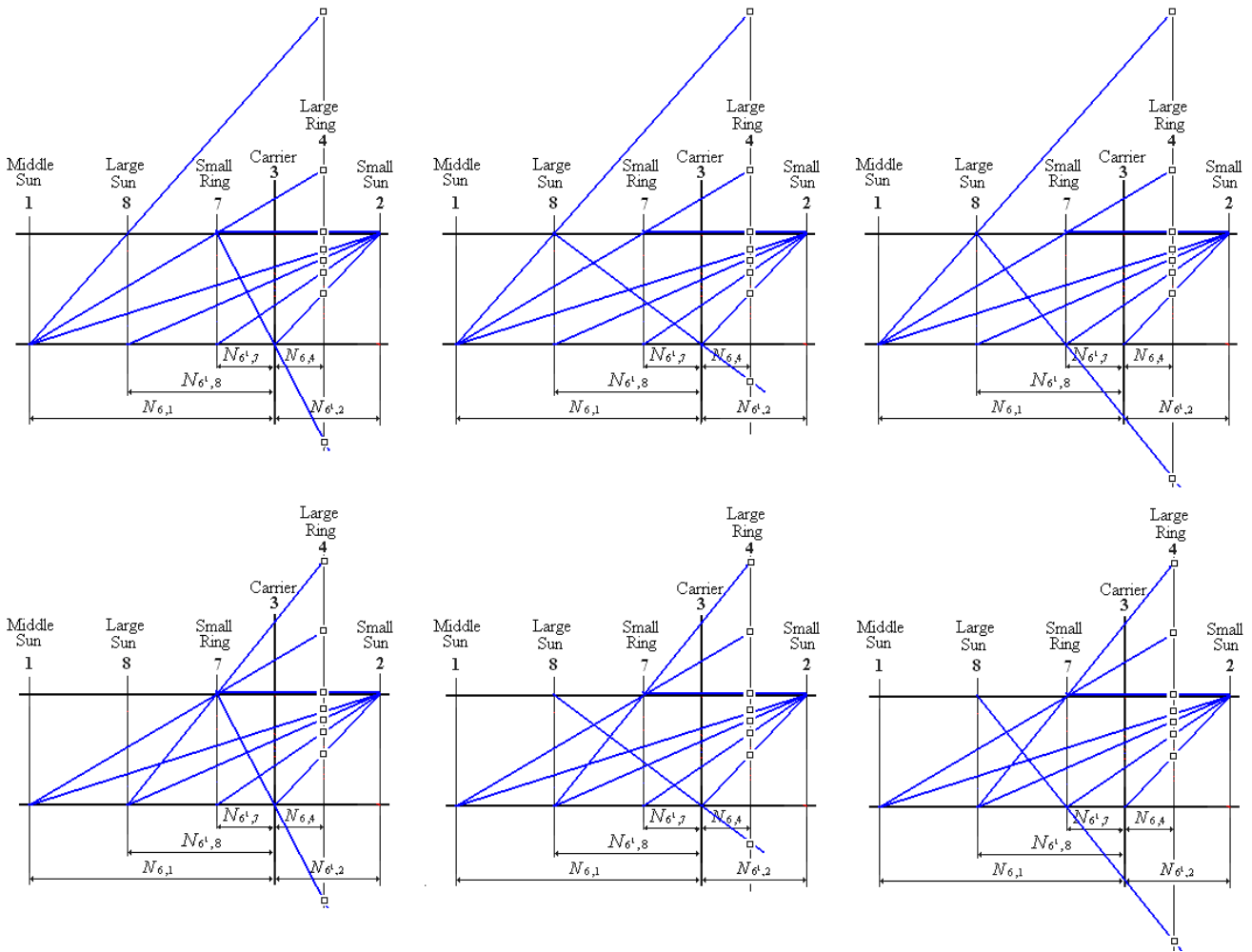

Figure 22 Clutching sequence nomographs for seven-velocity transmissions.

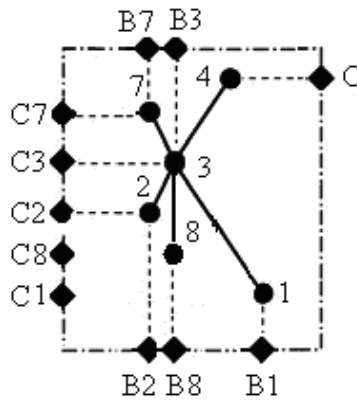

Figure 23 Feasibility graphs for the Ravigneaux gear train.

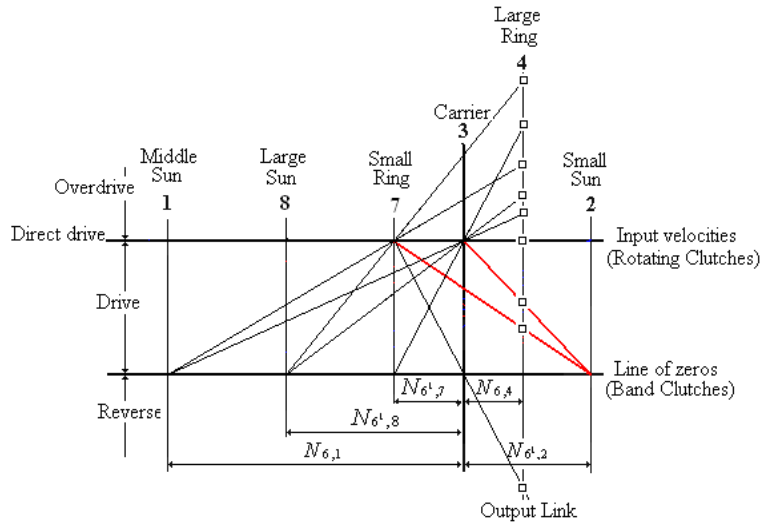

Figure 24 Clutching sequence nomograph for the nine-link Ravigneaux gear train based on the second UD set feasibility graph.

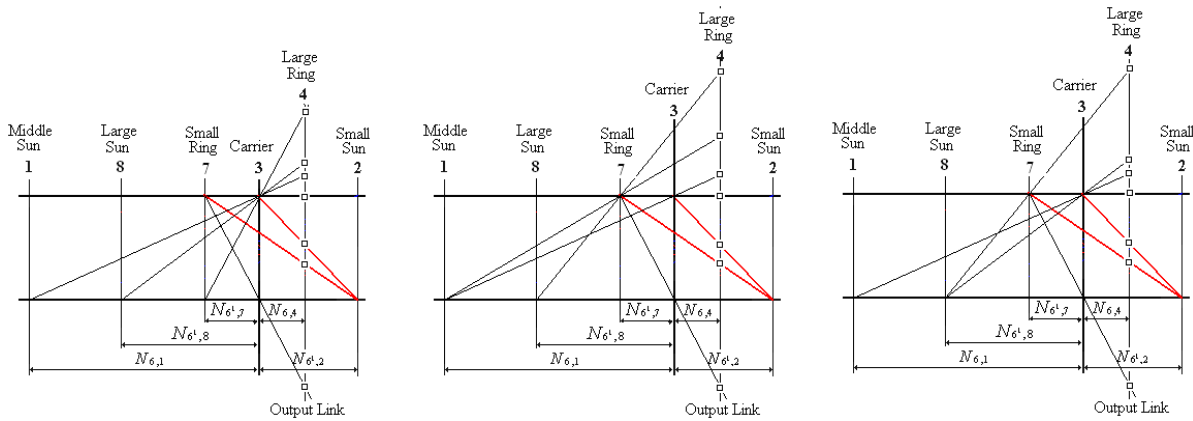

Figure 25 The three feasible clutching sequences for six-velocity automatic transmissions.

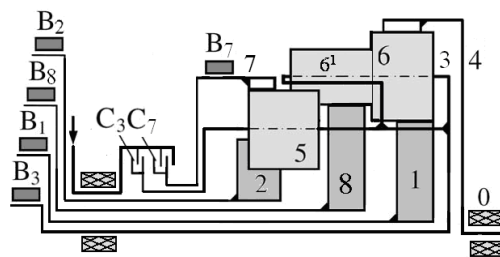

Figure 26 Clutching sequence layout for the nine-link Ravigneaux gear train based on the second UDs, ODs and RDs.